

Complete Streets

Building it Better

1/25/2022



alta

Agenda

- Welcome & Introductions
- Opening Remarks
- Why Are We Here?
 - SMCTA Role & Programs
 - Key Objectives & Goals of Complete Streets
- What Features Make Complete Streets?
- How Do We Build Better?
 - Major Corridors
 - Alternative Corridors
- When Are Upcoming Funding opportunities Available?

For Participants:

- Be ready to answer questions on your phone or computer

www.menti.com

Code: **2476 2790**

- Turn off background apps, email, and silence phone
- Ask questions via the Q&A Box
- The presentation will be recorded and the PowerPoint will be posted



Introductions



Rico E. Medina
Chair, SMCTA Board of
Directors
Mayor, City of San Bruno



Heba El-Guindy
SMCTA
Deputy Director



Joe Gilpin
Alta Planning and Design
Principal



Patrick Gilster
SMCTA
Manager of Programming
& Monitoring

Introduce yourself to us by adding your name and email to the chat!



Opening Remarks



Rico E. Medina

Chair, SMCTA Board of Directors & Mayor, City of San Bruno

Why Are We Here?

Heba El-Guindy
SMCTA Deputy Director

Transportation Authority

The San Mateo County Transportation Authority (TA) manages the voter approved Measure A & Measure W sales taxes that fund various types of transportation improvements. The TA is striving to better incorporate Complete Streets across all our programs.



Highways



**Local Streets
and Roads**



**Grade
Separations**



Transit



**Pedestrian
and Bicycle**



**Transportation
Demand
Management**

Defining Complete Streets

Complete Streets is the practice of considering the mobility needs of all roadway users including people who walk, cycle, scoot, take transit and drive; and it is important to all projects funded and implemented by the TA.



Transportation Authority Objectives

- **Enhance Safety Conditions**
- **Work Towards a Multimodal Transportation Network that Serves all Users in a Sustainable and Equitable Manner**
- **Improve Mobility and Roadway Comfort**
- **Funding Policies Changing; Create Competitive Projects**



What Features Make Complete Streets?

Joe Gilpin

Principal, Alta Planning & Design

Safety

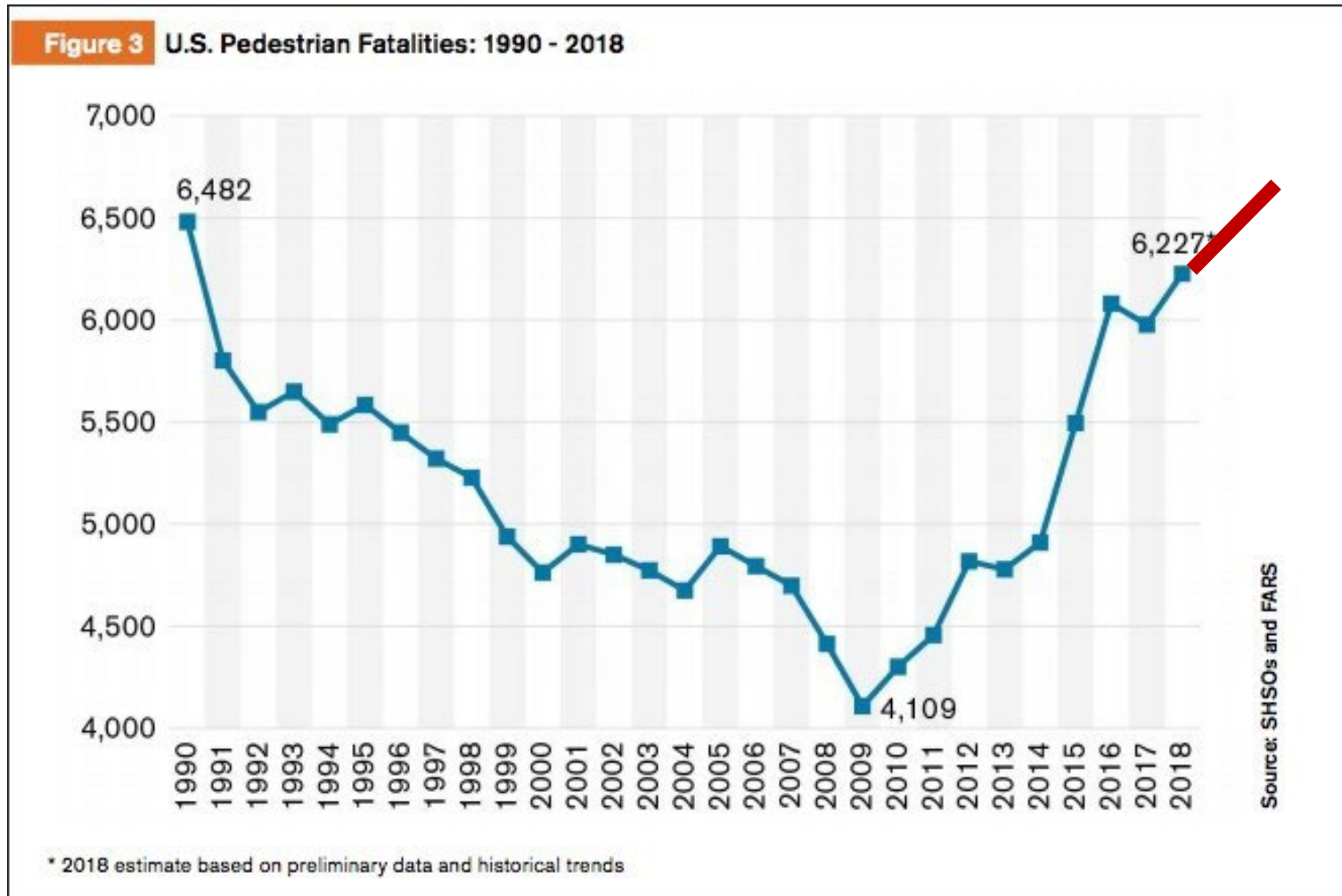

6,721 in 2020



Safety

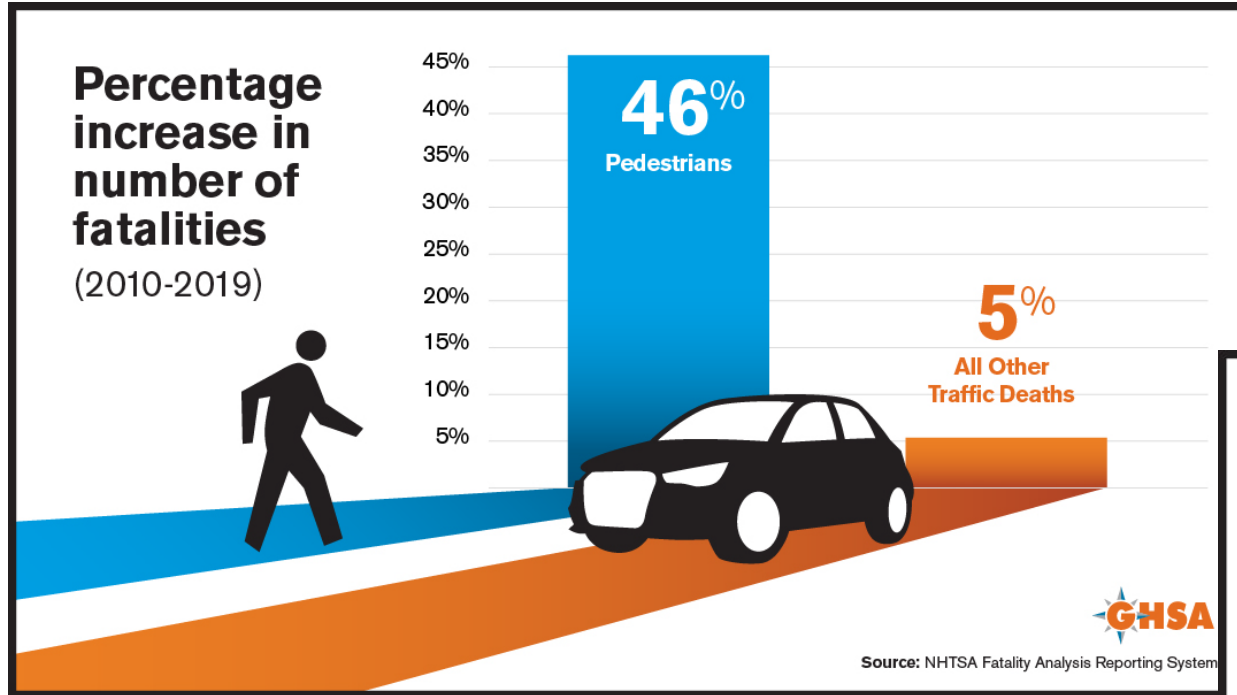

Safety

- Year over year pedestrian fatalities increased 21% from 2019-2020
- National VMT dropped 15% in 2020 due to COVID

2020 PRELIMINARY DATA ADDENDUM

Figure 3 Annual Percent Change in Pedestrian Fatality Rate Per One Billion VMT, 1976-2020

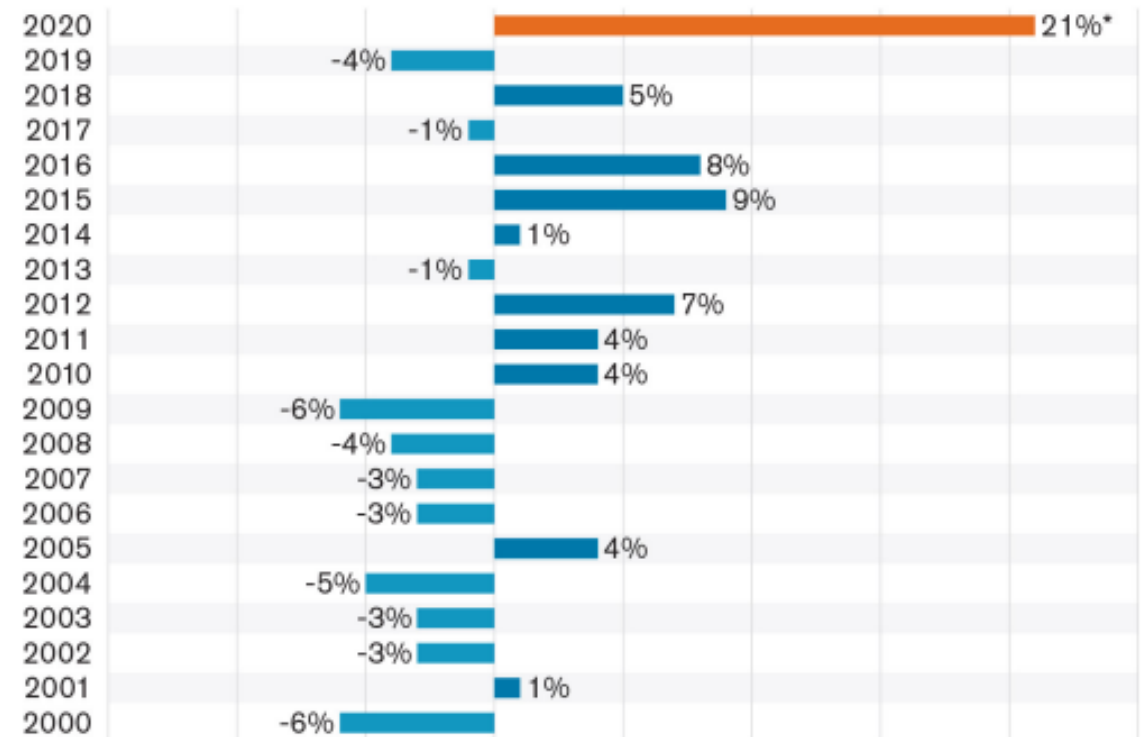

Safety – San Mateo County (Pedestrians)

1,242
Crashes Involving Pedestrians



52
Fatalities
1,297
Injuries

3 Root Causes
Totalling **78%**
of Crashes

20%
Result in a fatal or life altering injury



20%
Occurred on State Highways



32%
Occurred at Night



Failure to Yield
by Driver



Pedestrian
Violation



Unsafe
Speed

Data 2014-2018: Source San Mateo County Comprehensive Bicycle and Pedestrian Master Plan Update



Safety – San Mateo County (Pedestrians)

52%

Occurred in Intersections

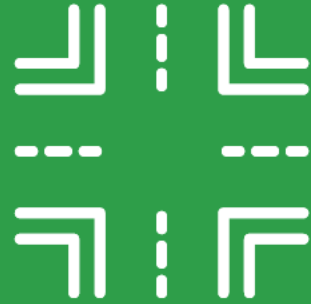

52%

Occurred in a Crosswalk in an Intersection

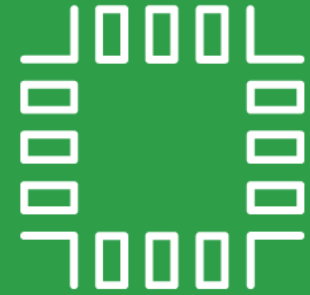

34%

Occurred in controlled Intersection



21%

Occurred When Crossing Outside of a Crosswalk



Data 2014-2018: Source San Mateo County Comprehensive Bicycle and Pedestrian Master Plan Update



Safety – San Mateo County (Bicycles)

1,187
Crashes Involving Bicyclists



9 Fatalities
1,218 Injuries

3 Root Causes
Totalling **57%** of Crashes

10%
Result in a fatal or life altering injury



17%
Occurred on State Highways



Failure to Yield
by Driver



Improper
Turning



Unsafe
Speed

Data 2014-2018: Source San Mateo County Comprehensive Bicycle and Pedestrian Master Plan Update



Safety

These are just the ones we have crash reports for!



Vision Zero/Safety Plan

- Collection of **policies, standards, practices and actions** aimed at reducing/eliminating fatalities and severe injury collisions especially involving vulnerable roadway users namely pedestrians and cyclists.
- Most engineering principles associated with Vision Zero are focused on managing speed.

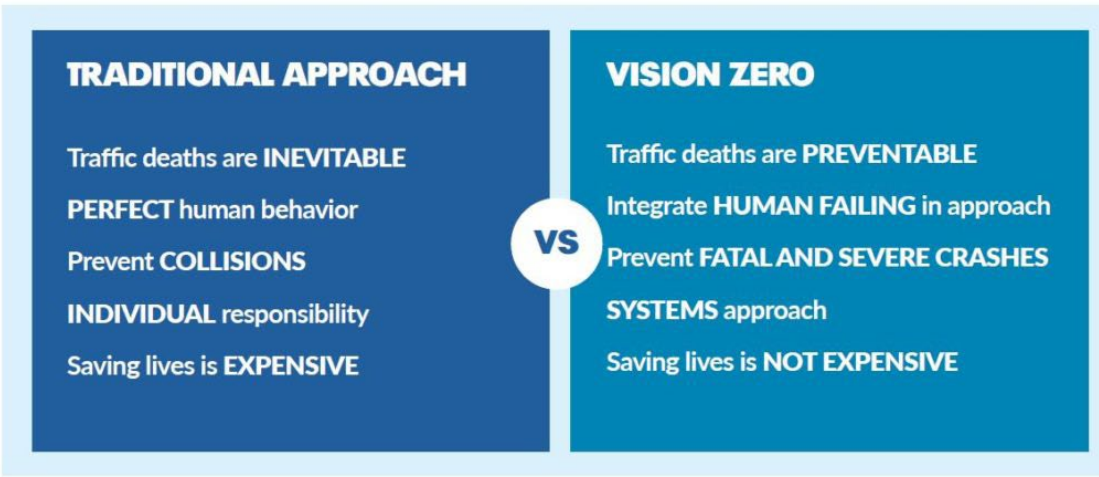

Key Vision Zero Highlights:

- MTC adopted a Regional Safety/Vision Zero Policy
- C/CAG CBPP includes Vision Zero goals and recommends the development of Systemic Safety Program
- 6 cities in San Mateo county have Vision Zero goals
- Only 1 city has a Vision Zero Action Plan



How Fast Would You Drive Here?



Answer questions on your phone or computer using:

www.menti.com

Code: 2476 2790



How Fast Would You Drive Here?

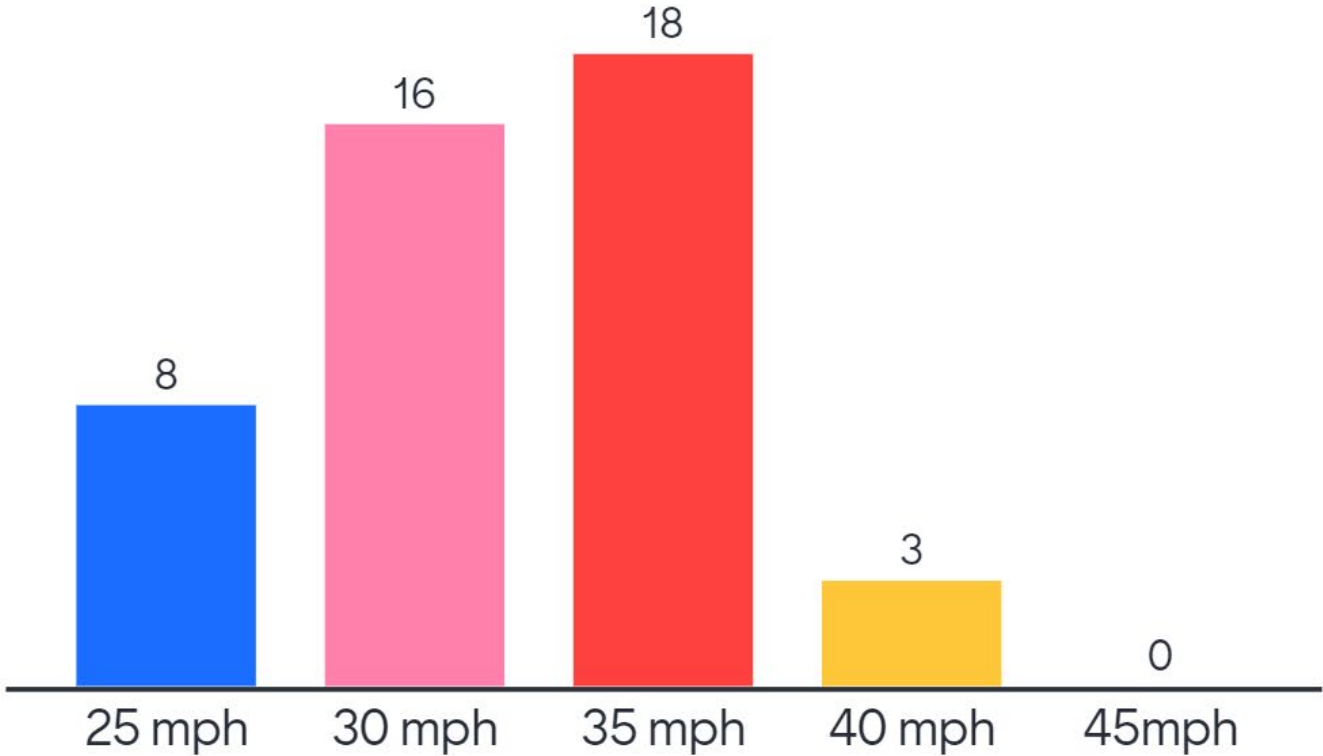

How Are Speed Limits Set?

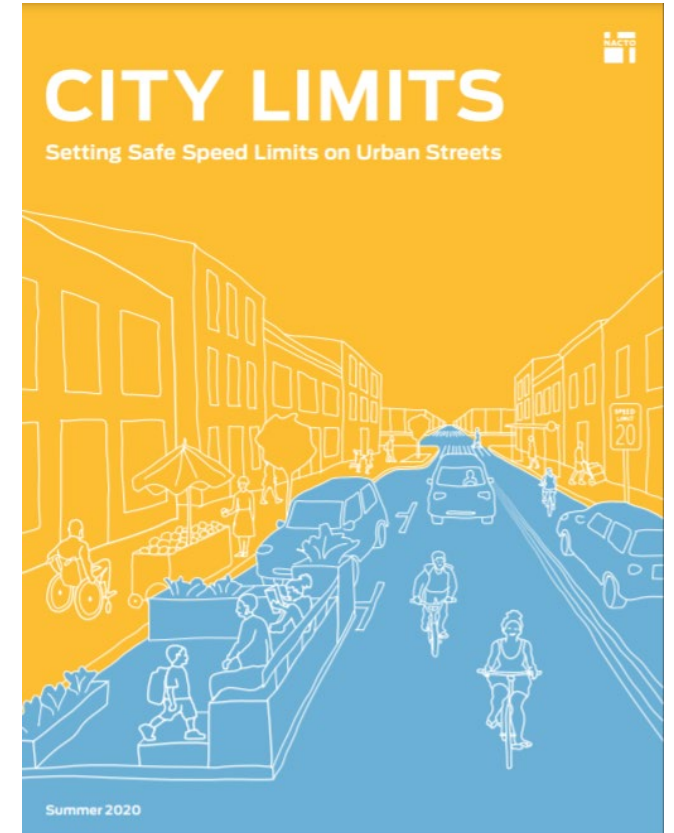
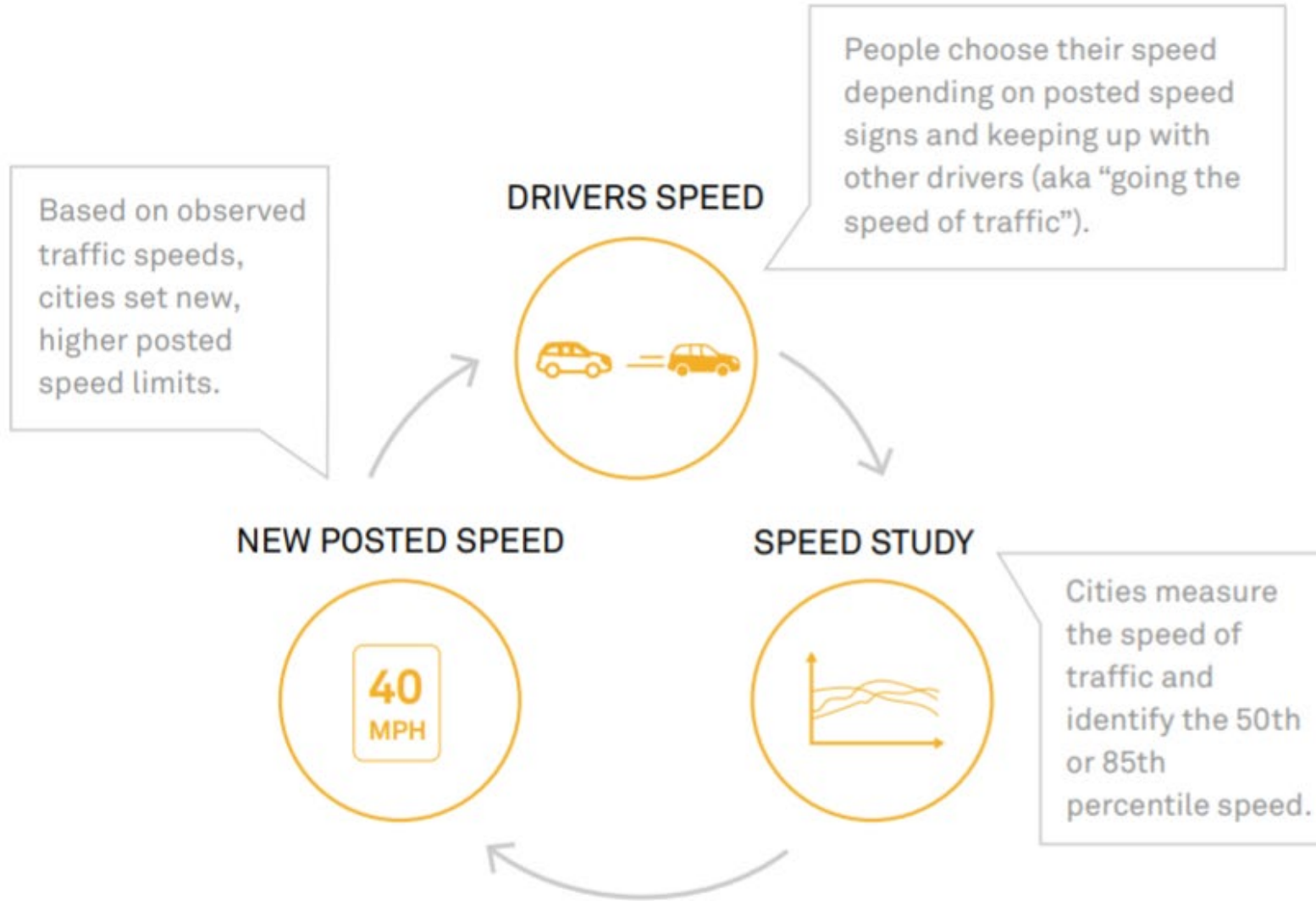

How Driver Speed Affects Perception



PERIPHERAL VISION AT 10-15 MPH



How Driver Speed Affects Perception



PERIPHERAL VISION AT 20-25 MPH



How Driver Speed Affects Perception



PERIPHERAL VISION AT 30-35 MPH



Speed Vs Stopping Distance

Cars travelling faster take longer to stop

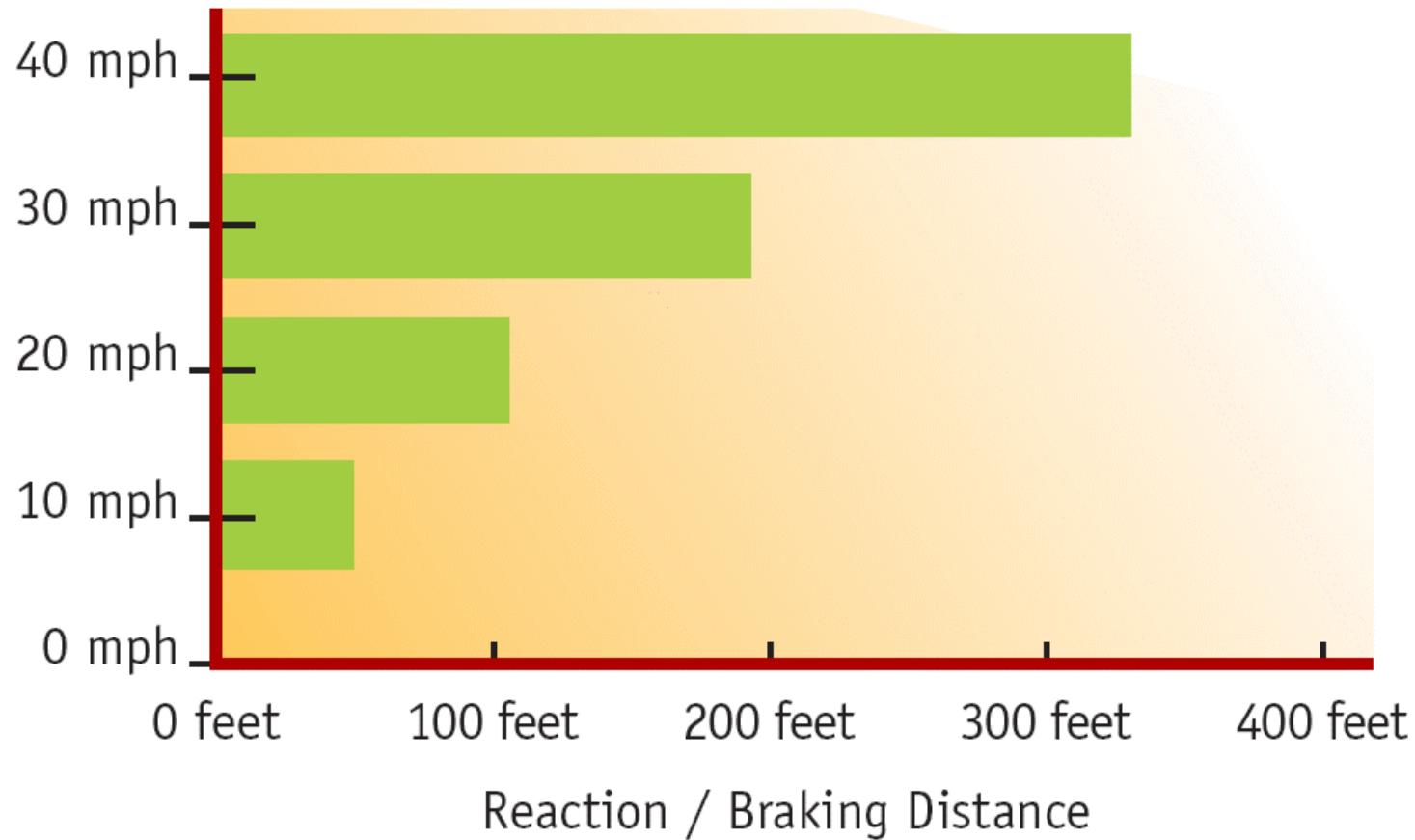

Risk of Pedestrian Fatality in a Collision

The Chance of Being Killed by a Car Going 20 mph

Roll over the curved lines to see the risk at any speed

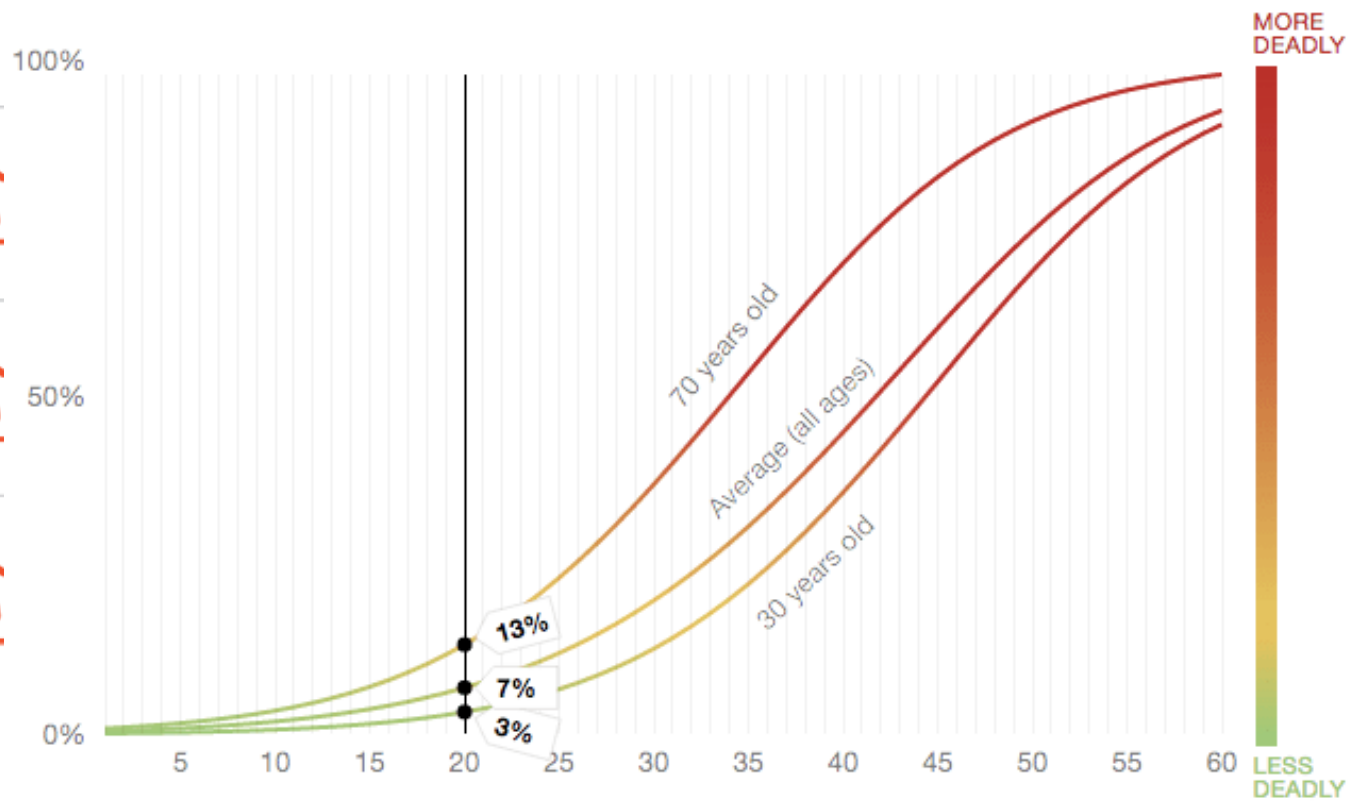

Risk of Pedestrian Fatality in a Collision

- Risk of fatality data is from 1990s
- What is different since then?



Risk of Pedestrian Fatality in a Collision

- Vehicle size
- Front shape/height
- Vehicle mix
- Infotainment
- Cell Phones
- More vehicles!



Light trucks (pickups, SUVs, crossovers) accounted for a record 75.9% share of U.S. auto sales in 2020, up from 71.7% in 2019. In 2012, just nine years ago, trucks were 53% of the total.

Risk of Pedestrian Fatality in a Collision

It Took 13 Kids In Line For An SUV Driver To Spot Them And This Highlights A Disturbing Issue- Front Blind Zones

65 Shares



Reduce Posted Speed within Allowed Regulations

- Seattle experience promising
 - Some streets reduced from 30 to 25mph
 - Speed limit sign frequency increased to ¼ mile in each direction
 - Early focus on urban villages
 - Estimated cost: \$4-5,000/mi



Crashes (Before/After)

Crashes	All Crashes	Injury Crashes
Before	517	193
After	403	158
% Change	-22%	-18%

*Source: Seattle GIS Collisions (<http://data-seattlecitygis.opendata.arcgis.com/>)

Change in Driver Speed (Before/After)

Speeds	50th Percentile	85th Percentile	40+ MPH Speeders
Before	25.6 MPH	31.2 MPH	1119
After	23.1 MPH	29.0 MPH	513
% Change	-9.9%	-7.1%	-54.1%

How comfortable would you feel...?

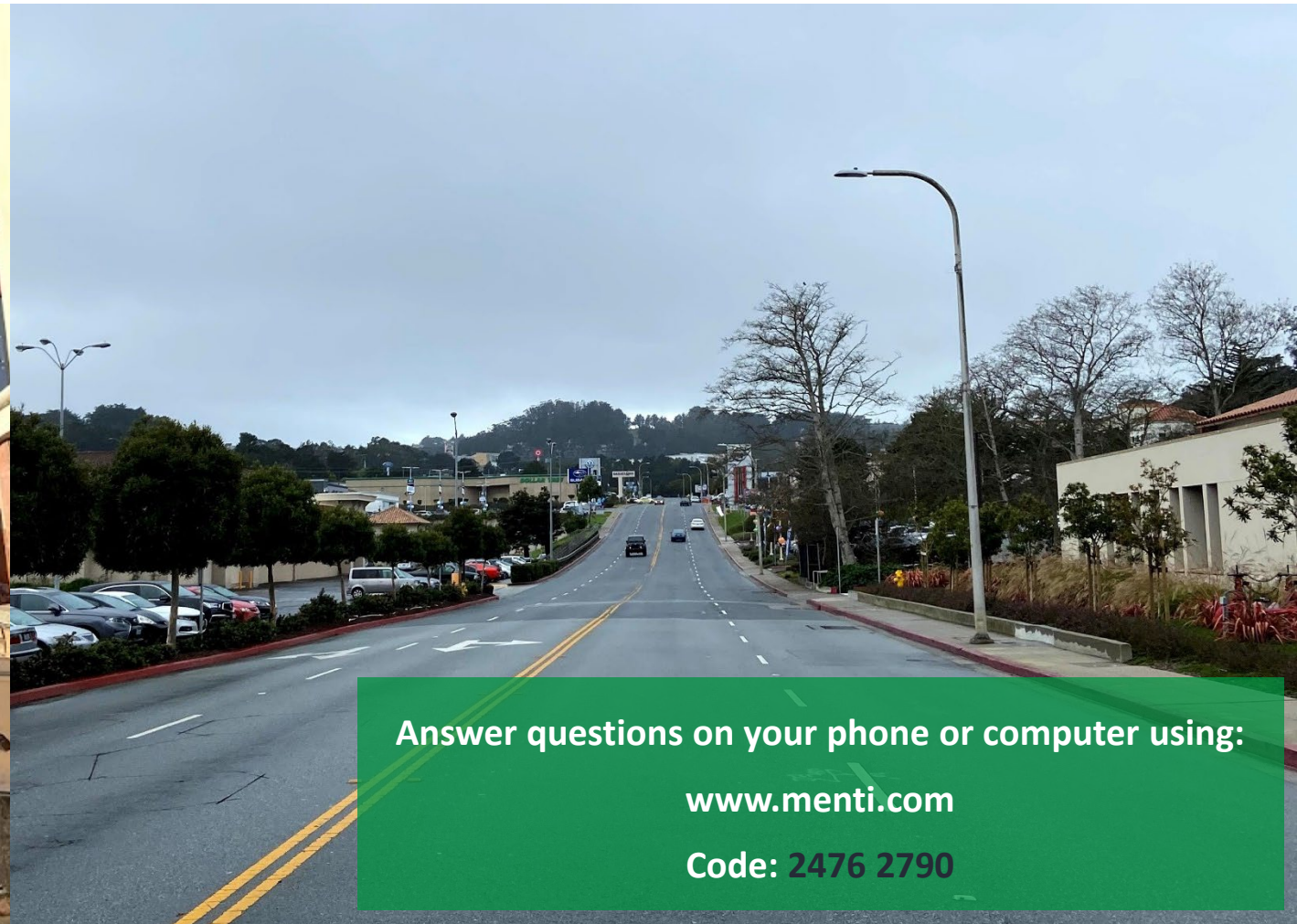

Answer questions on your phone or computer using:

www.menti.com

Code: 2476 2790



How comfortable would you feel?

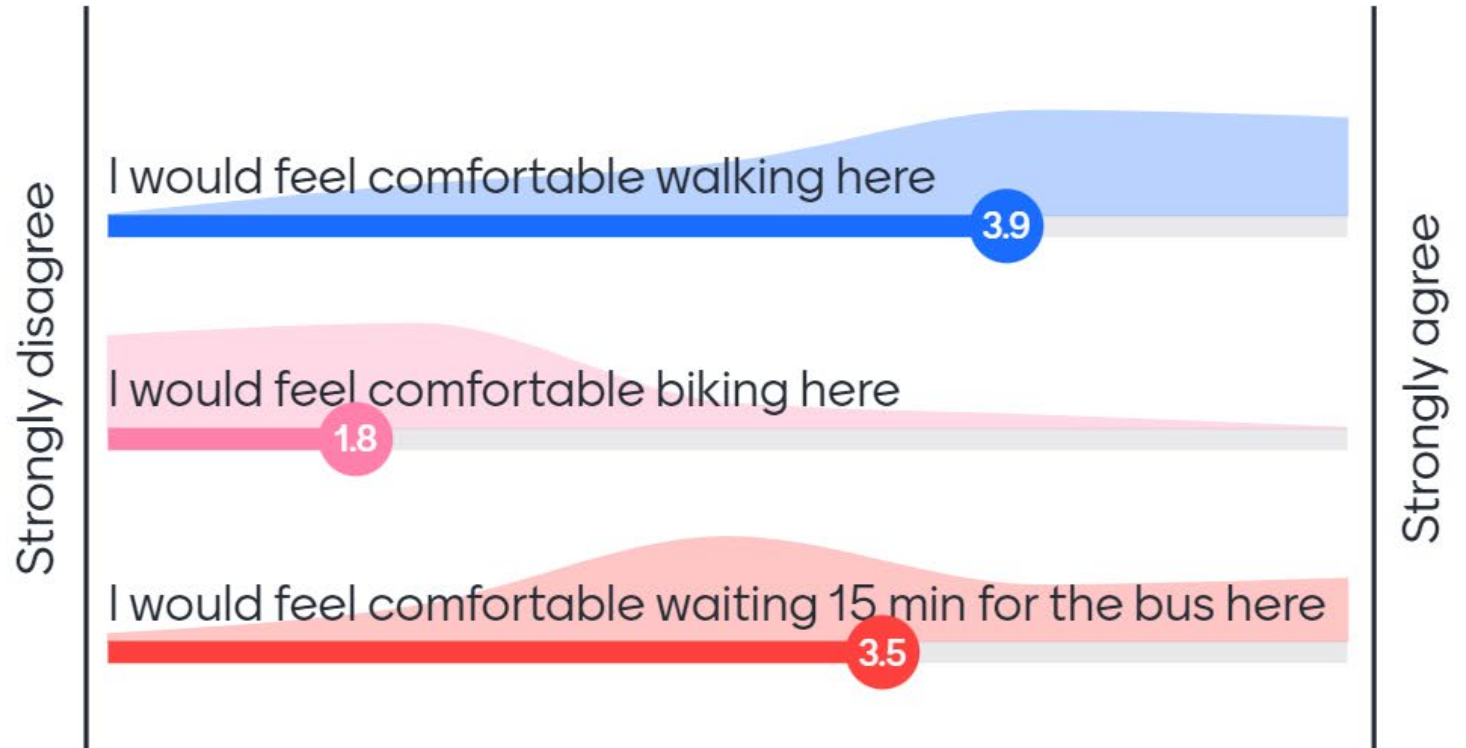

Improve Roadway Comfort - Pedestrians



Convenient Access and Connectivity between Pedestrians and Transit Services

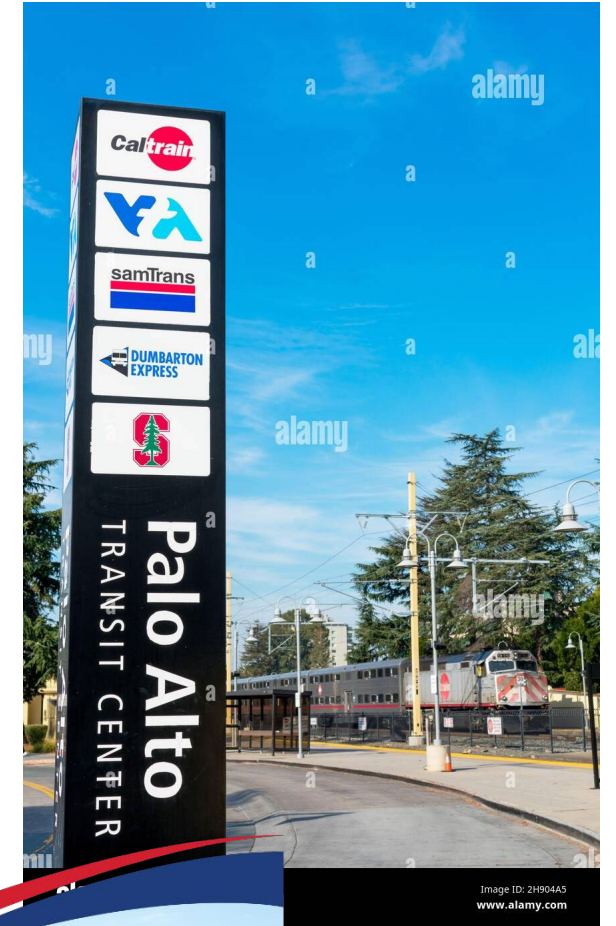

GET 2 SCHOOL
ON SAMTRANS

Call 1-800-660-4287
(TTY 650-508-6448)



Improve Roadway Comfort - Bicyclists



Convenient Access and Connectivity between Bicyclists and Transit Services



Comfort and Sense of Security: Lighting

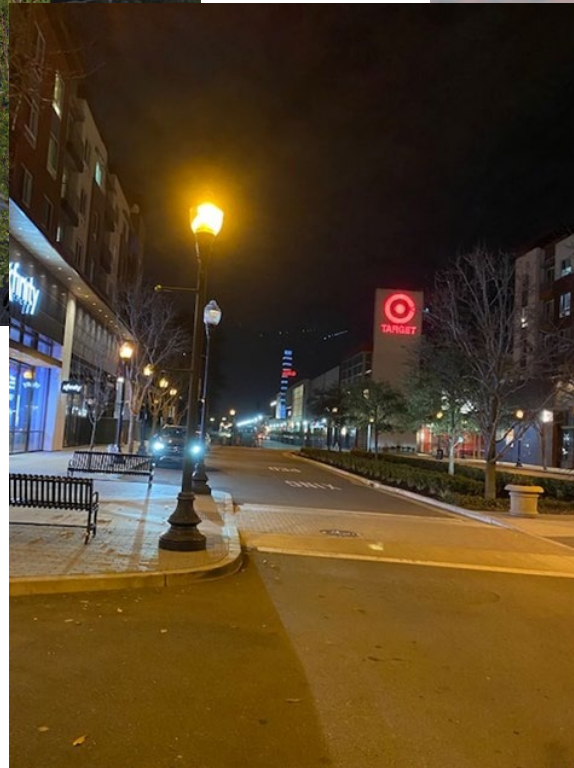

Comfort: Street Furnishings

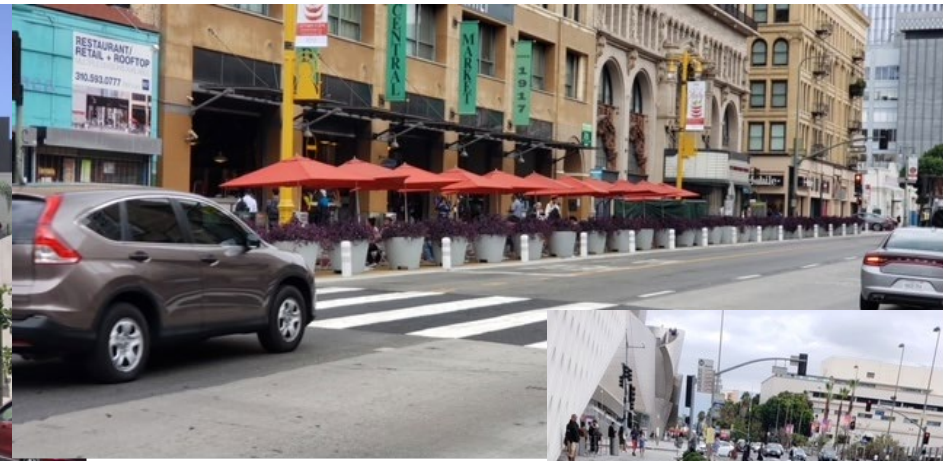

Improve Multimodal Travel Options



Improve Travel Options

-  Mobility Hubs
-  Priority Access Connections
-  Designated Centers and Corridors

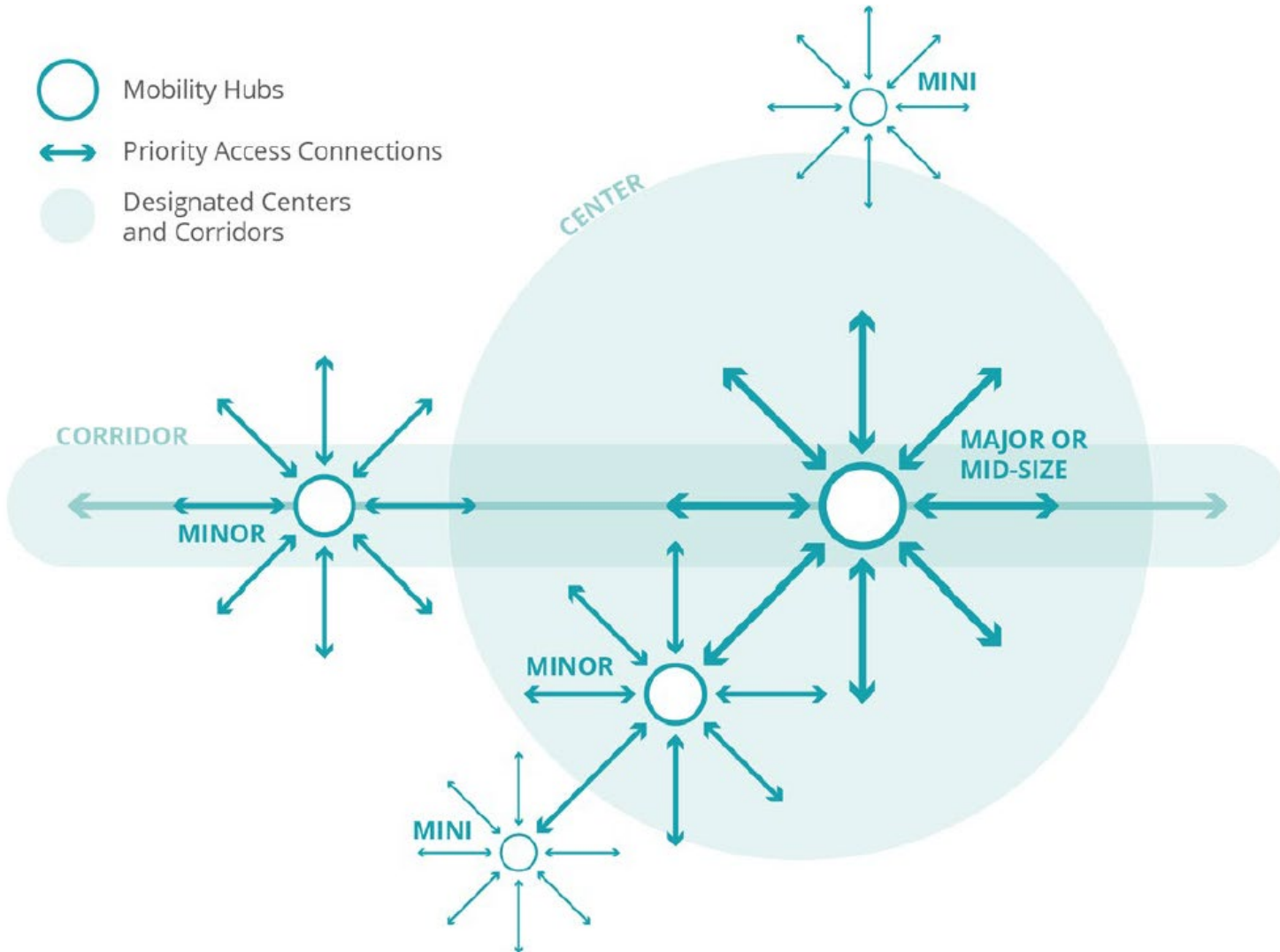

TRANSIT AND TRIP-MAKING SERVICES



Micro-transit pick up & drop off area



Transit ticket and integrated payment kiosks



Bus, shuttle, or light rail stop



Real time transit information & other shared mode information

PARKING AND CHARGING SERVICES



Electric vehicle charging



Short term bike parking



Long term bike parking



Bikeshare & scootershare parking



Freight loading/unloading area



Carshare parking and access points

PRIORITY ACCESS



Prioritized walkways



Prioritized bike and micro-mobility access



Safe bicycle and pedestrian crossings



Community space



Retail



Activated furnishing zone with appropriate support infrastructure

AMENITIES



Improve Travel Options

- A. Shuttle boarding platform
- B. Trip planning information that is accessible to all and ticket kiosks to facilitate pre-boarding payment
- C. Passenger pick-up and drop-off
- D. Retail space for businesses that support trip-chaining, such as bike shops, grocery/convenience stores, or coffee shops
- E. Short term bike parking
- F. Designated micromobility parking

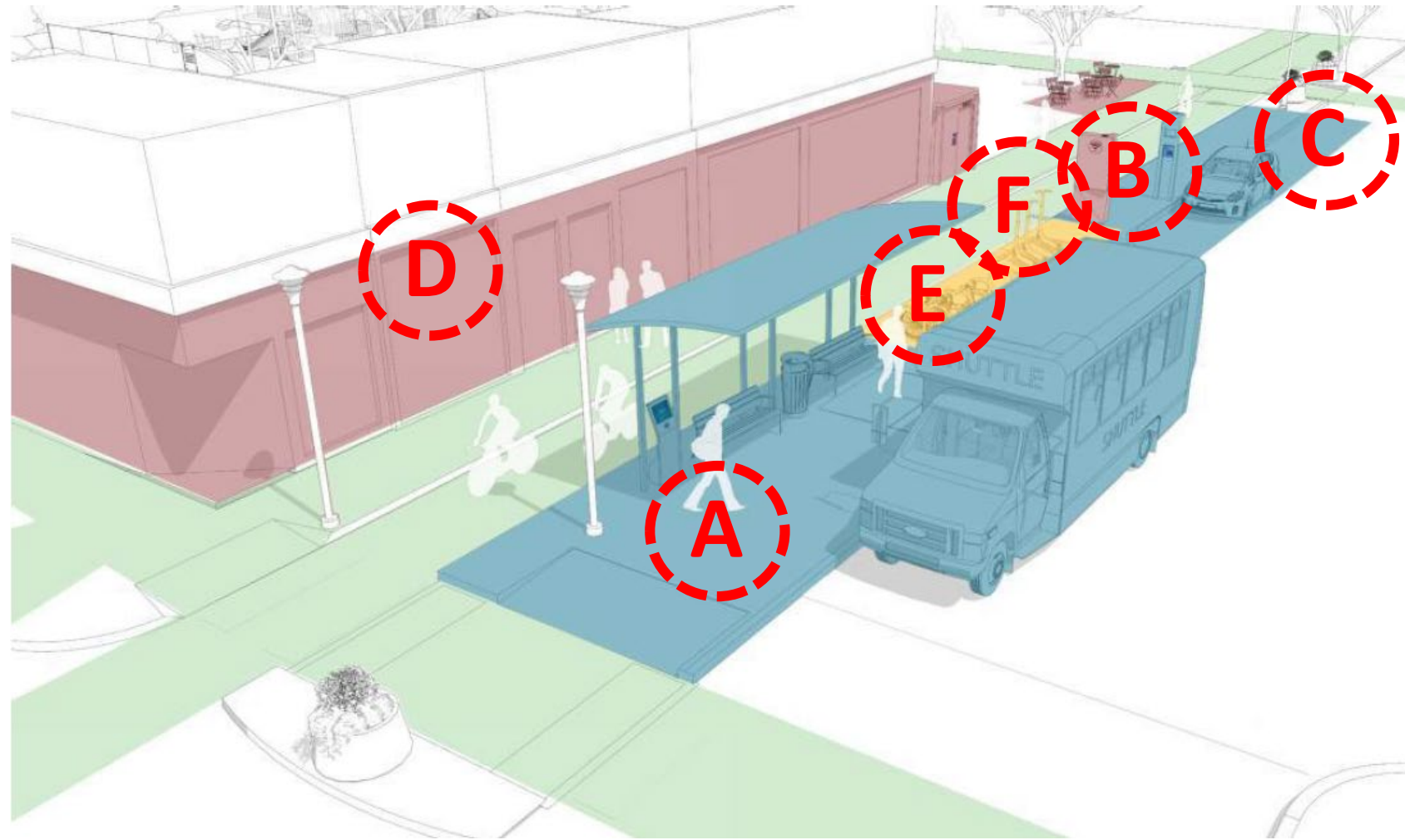



How Do We Build Better?

Joe Gilpin

Principal, Alta Planning & Design

Keep Standards Current & Flexible

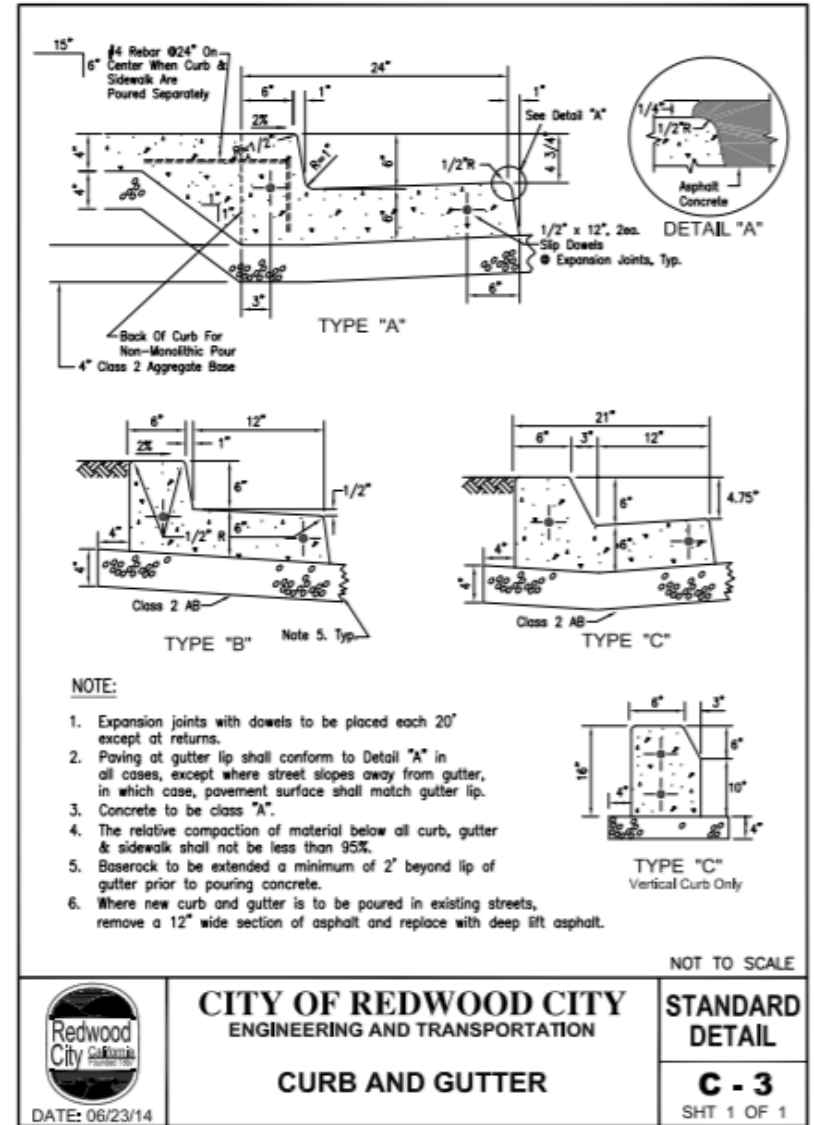
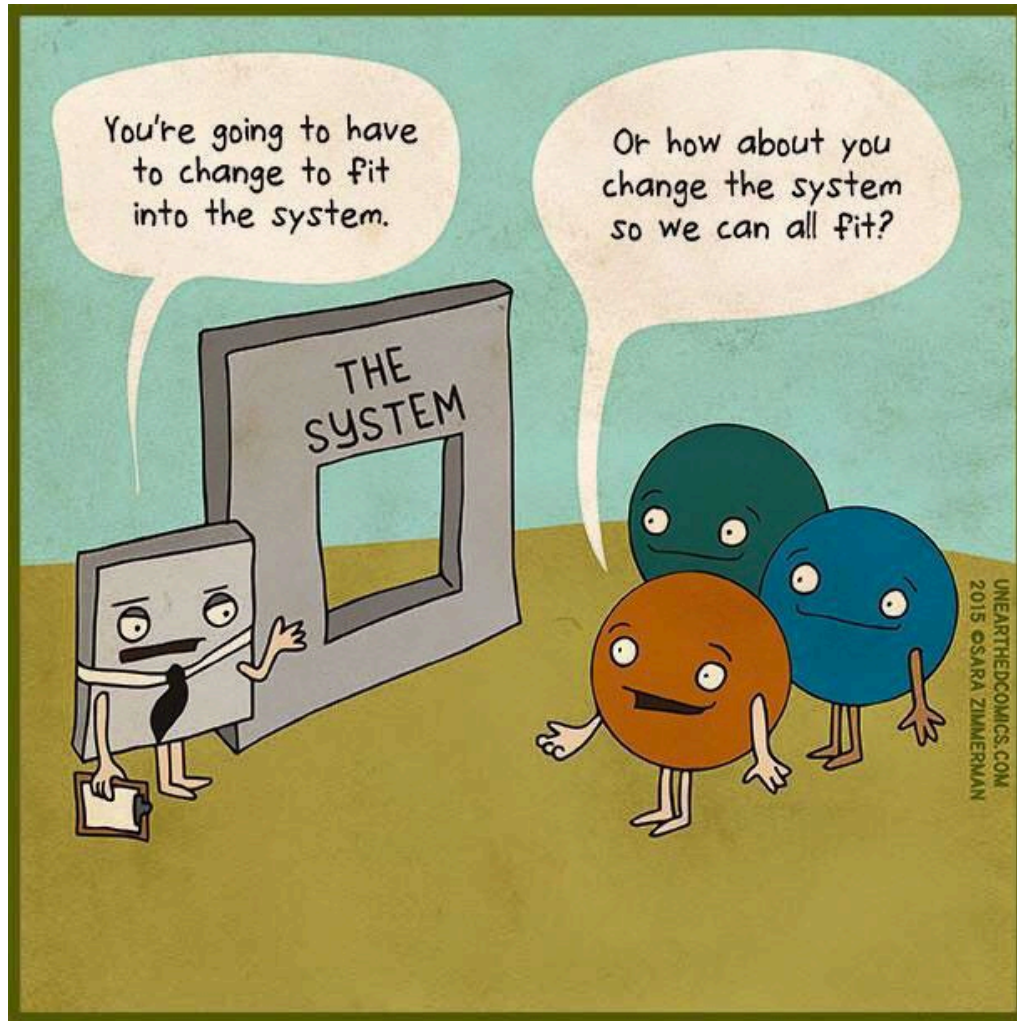

Keep National Guidance/Standards Current

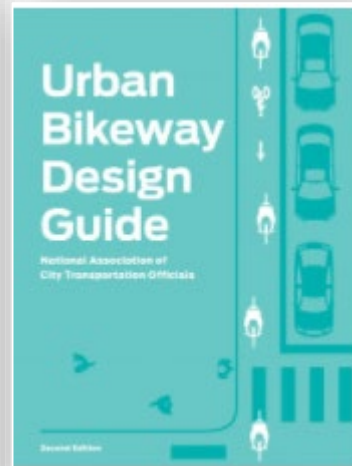
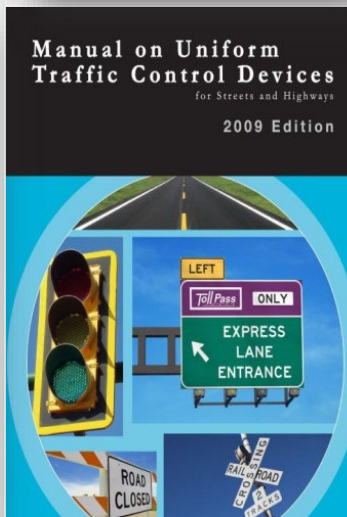
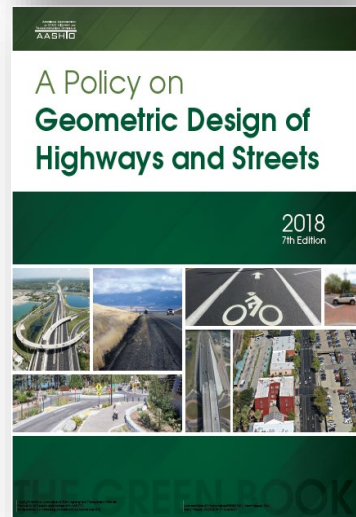
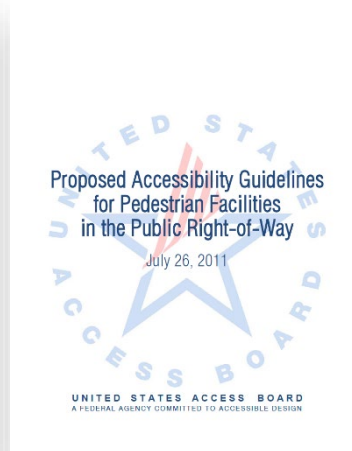
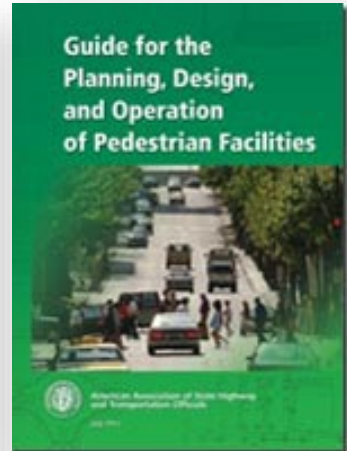
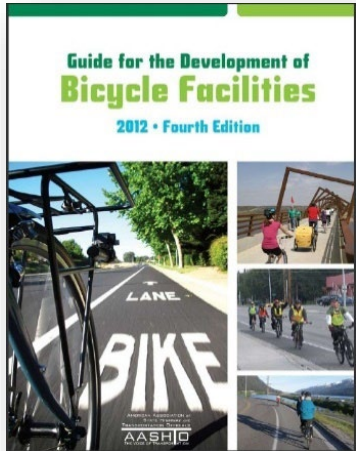

ALL MAJOR GUIDES / STANDARDS UNDER IMMEDIATE UPDATE OR ADOPTION

C/CAG Comprehensive Bicycle & Pedestrian Plan (2021) includes a Treatment Toolkit local agencies can reference.

https://ccag.ca.gov/wp-content/uploads/2021/05/CBPP_Appendix-A_Design-Toolkit.pdf



Be Flexible & Nimble

- Complete streets maximize use of space and often create the need to compromise.
- How are these conversations handled?
- Do agency policies, leadership, and staff support creativity or uniformity?



Invest in Staff Training

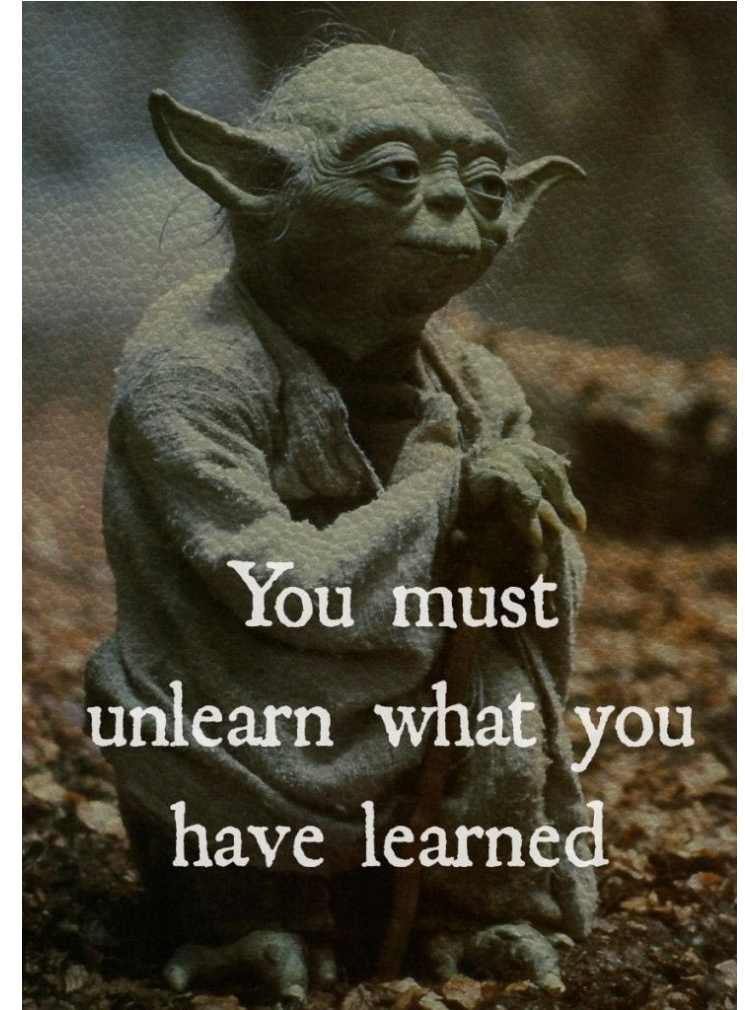

Leverage Project Opportunities

- Resurfacing
- Bridges
- Reconstructions
- Developer Improvements
- Utility Projects
- Safe Routes to Schools and Parks Projects
- Transit Projects



Partner With Other Goals - Utilities



Partner With Other Goals - Stormwater

- Curb Extensions
 - Mid-Block
 - Corners
- Medians





MAJOR CORRIDORS



How can we make them better?

Find More Space

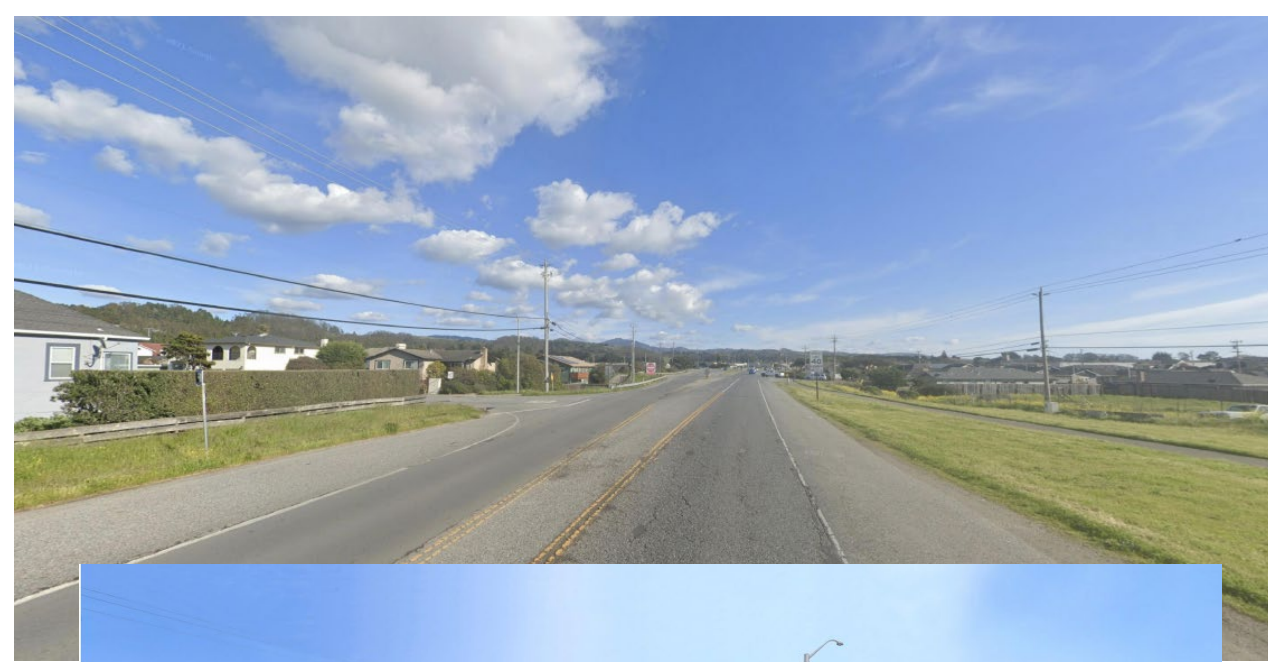

What's the Difference Between this Section of El Camino Real and Highway 1?



Find More Space

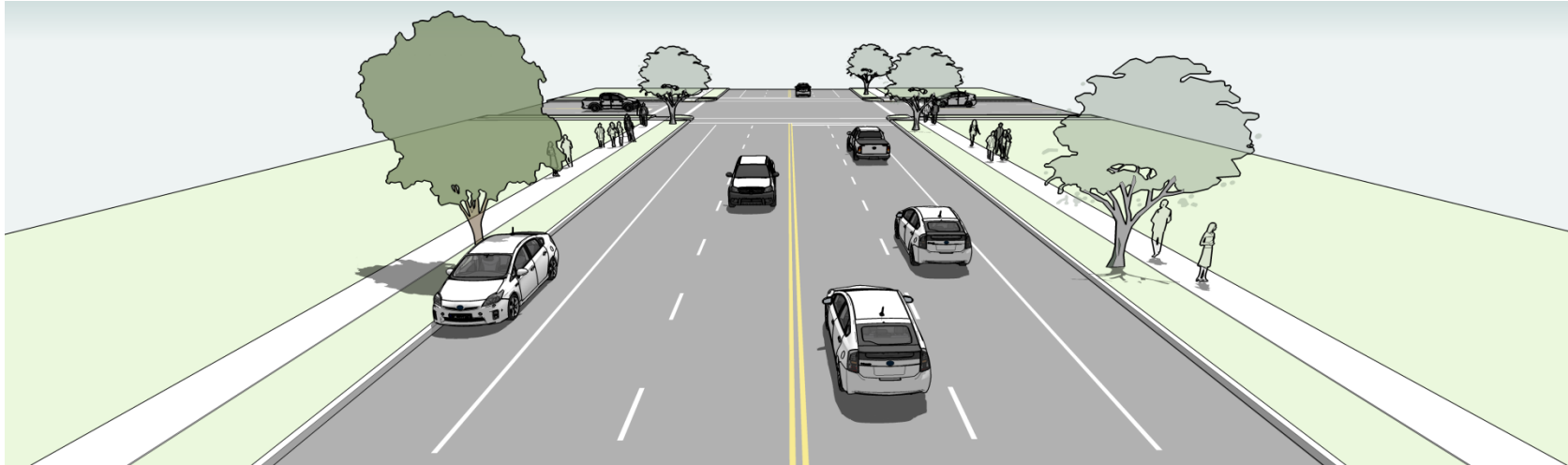

8 ft 10 ft 10 ft 10 ft 10 ft 8 ft

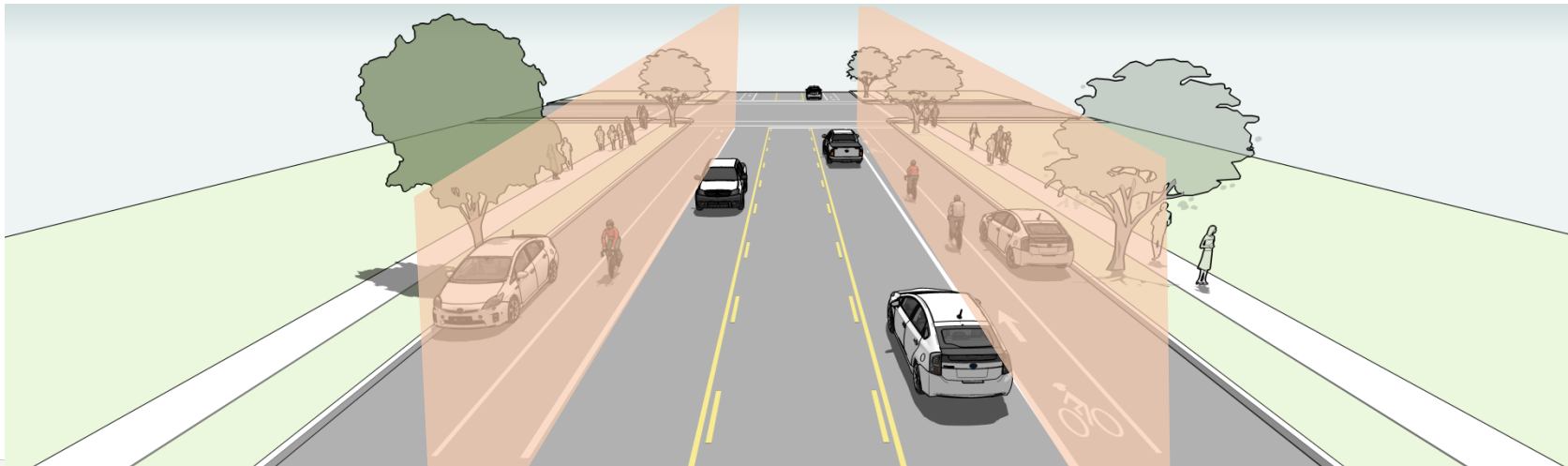

8 ft 5 ft 10 ft 10 ft 10 ft 5 ft 8 ft



Find More Space

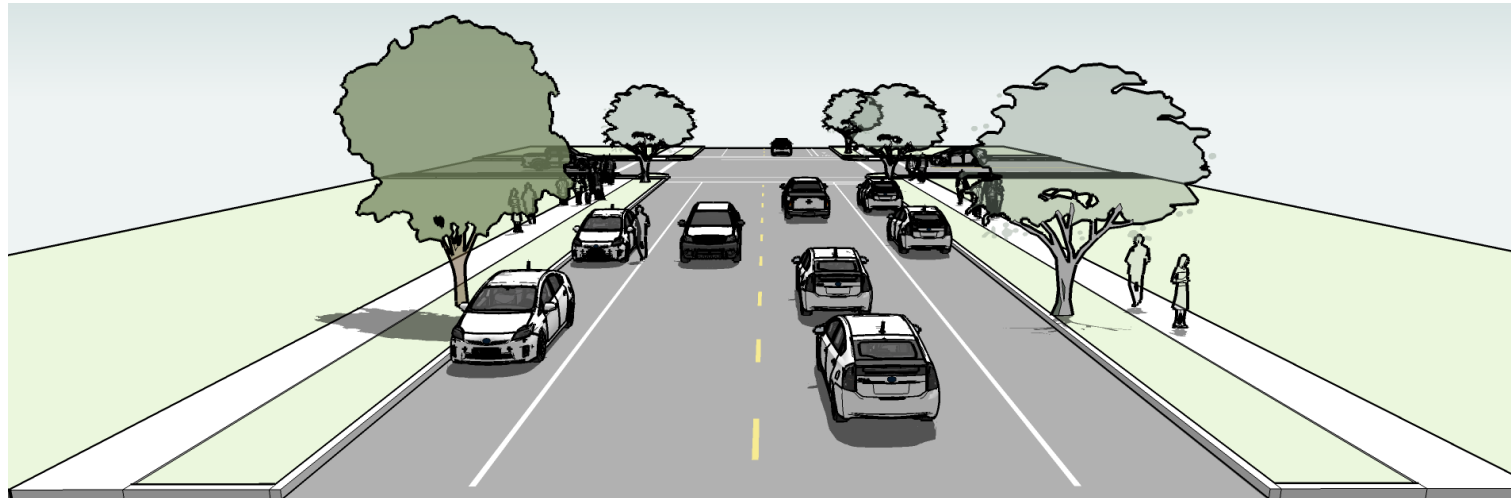

8 ft 12 12 8 ft

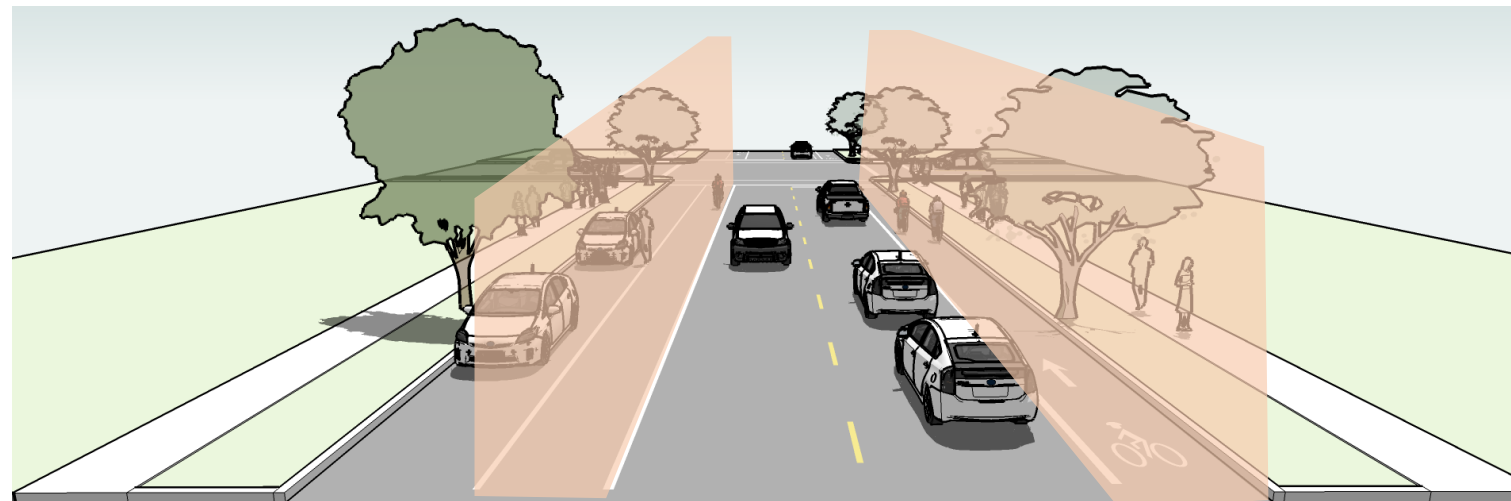

8 ft 6 ft 10 ft 10 ft 6 ft



Check Your Capacity - Vehicles

- Morgan Hill
- Monterey Road between Main Avenue and Dunne Avenue
- Pilot Project - 2015



PEAK PERIOD SPREADING: MONTEREY RD AND 1ST ST

MOTOR VEHICLE VOLUMES ARE MORE EVENLY DISTRIBUTED

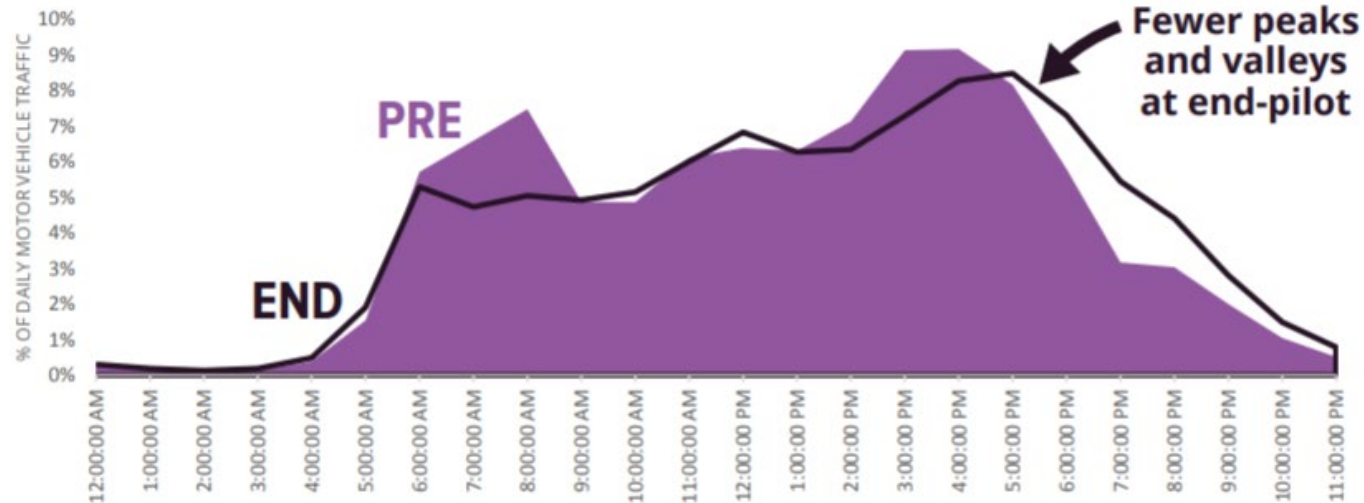

Check Your Capacity – Other Outcomes

- Morgan Hill
- Monterey Road between Main Avenue and Dunne Avenue
- Pilot Project - 2015

RACE: NON-WHITE

↑ 54% IN DIVERSITY AMONG PEOPLE BICYCLING

AGE: UNDER 18

↑ 614% IN THE NUMBER OF KIDS BICYCLING

ON SIDEWALK + UNDER 18

↓ 52% IN THE PERCENT OF KIDS RIDING ON THE SIDEWALK
and a 48% decrease overall

IN A GROUP

↑ 81% IN PEOPLE BICYCLING IN A GROUP

BICYCLE COUNTS

PRE **MID** **END** **PEOPLE BIKING NEARLY TRIPLED**
74 → 170 → 214
(189% increase from pre- to end-pilot)



TRANSIT RIDERSHIP

↑ 3% BUS ON/OFFS INCREASED*
at Downtown bus stops. Total trip length increased by 29 seconds.
*Adjusted for seasonality



PEDESTRIAN DELAY*

NO CHANGE
Pedestrian wait time and the motor vehicle yield rate did not change from pre- to end-pilot



*No significant traffic signal or intersection alterations were made during the pilot outside of reducing the number of travel lanes (overall crosswalk width remained the same)

TRAVEL TIME RELIABILITY

PRE **MID** **END** **MORE PREDICTABLE TRAVEL TIMES**
20 → 52 → 15
SEC SEC SEC
After an initial adjustment period, the amount of extra time people driving had to factor into their morning trip through Downtown to account for fluctuations in average trip time ("buffer time") decreased from pre- to end-pilot by 25 percent



Fund The Future You Want



- San Luis Obispo’s Climate action Plan sets mode share targets – CIP backs it
- San Jose has mode share objectives, developed Complete Streets Design Guidelines, and developed Vision Zero Action Plan.
- Culver City developed a Complete Streets Policy, set mode share objectives in an updated Bicycle and Pedestrian Action Plan, developed a Safety Plan, and obtained grants to develop Complete Streets Design Guidelines and Climate Action Plan.



Fund The Future You Want

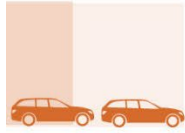

PRIVATE MOTOR VEHICLES
600–1,600/HR



MIXED TRAFFIC WITH FREQUENT BUSES
1,000–2,800/HR



TWO-WAY PROTECTED BIKEWAY
7,500/HR



DEDICATED TRANSIT LANES
4,000–8,000/HR



SIDEWALK
9,000/HR



ON-STREET TRANSITWAY, BUS OR RAIL
10,000–25,000/HR



Large Intersections – Problems

- Long Pedestrian Crossings
- Cars move faster creating more severe crashes when they occur
- Fast car turning:
 - Increases stopping distance
 - Reduces chances to yield
 - Increases crash risk and severity

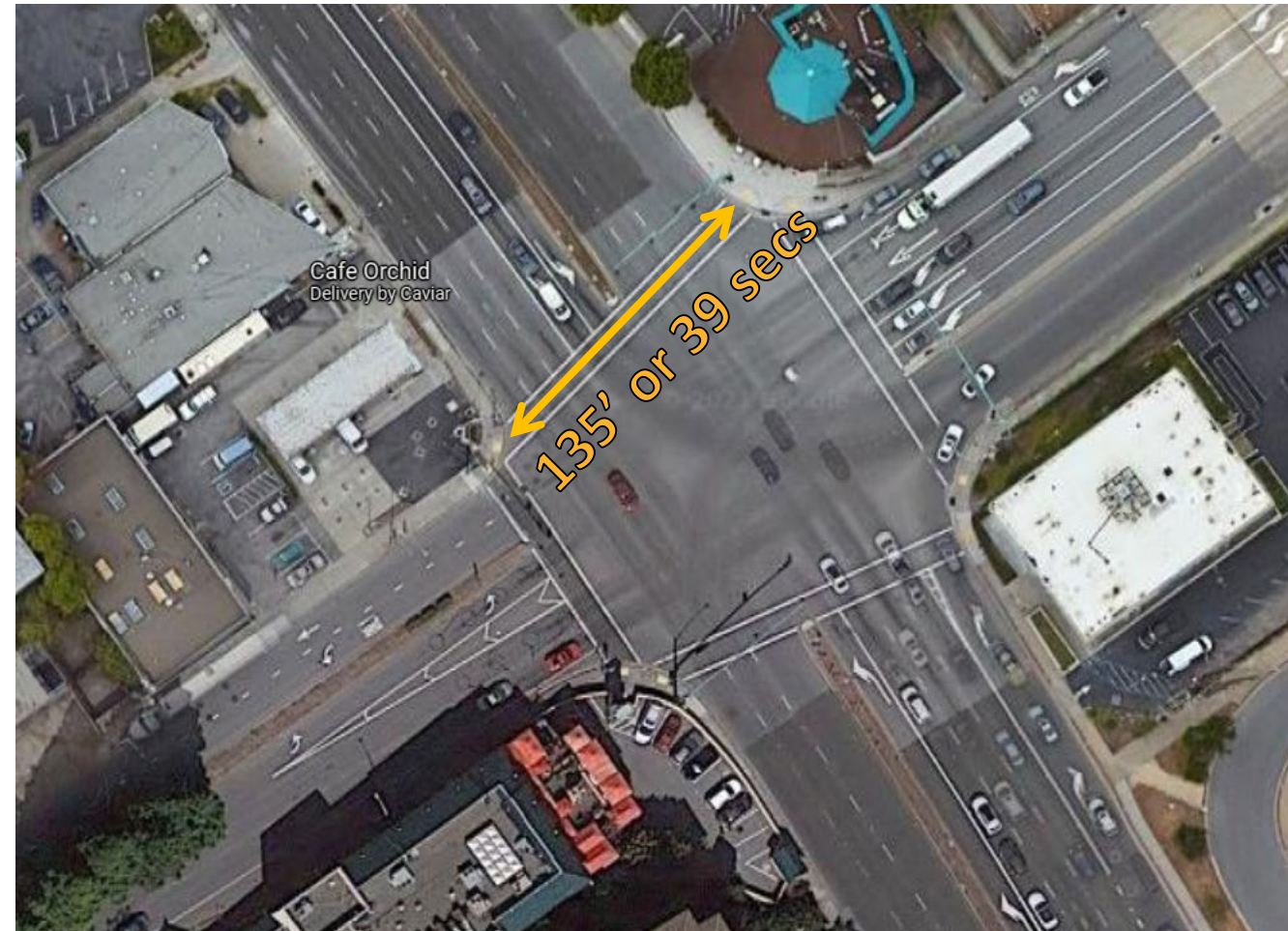

Why Do We Have Large Corner Radii?

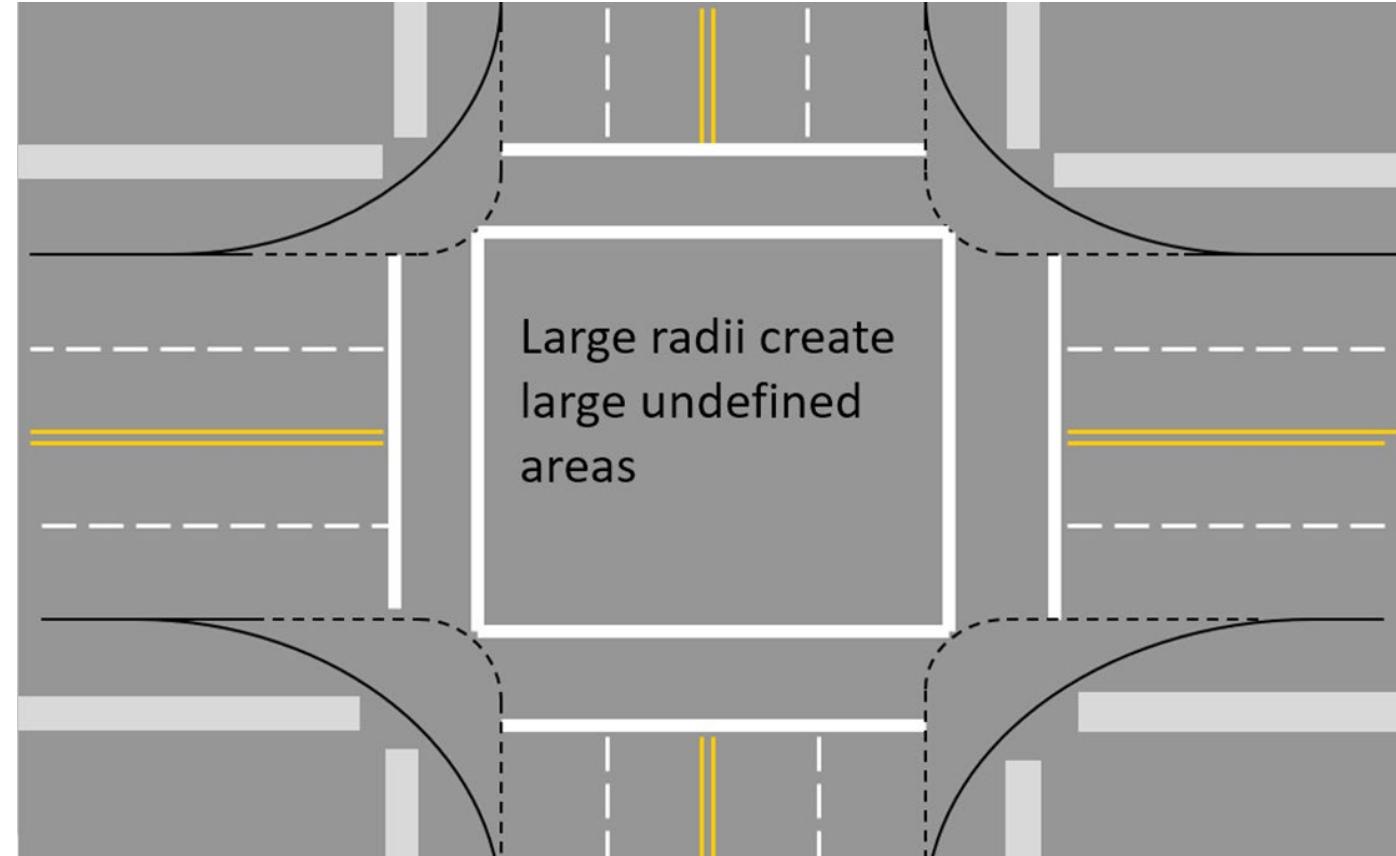
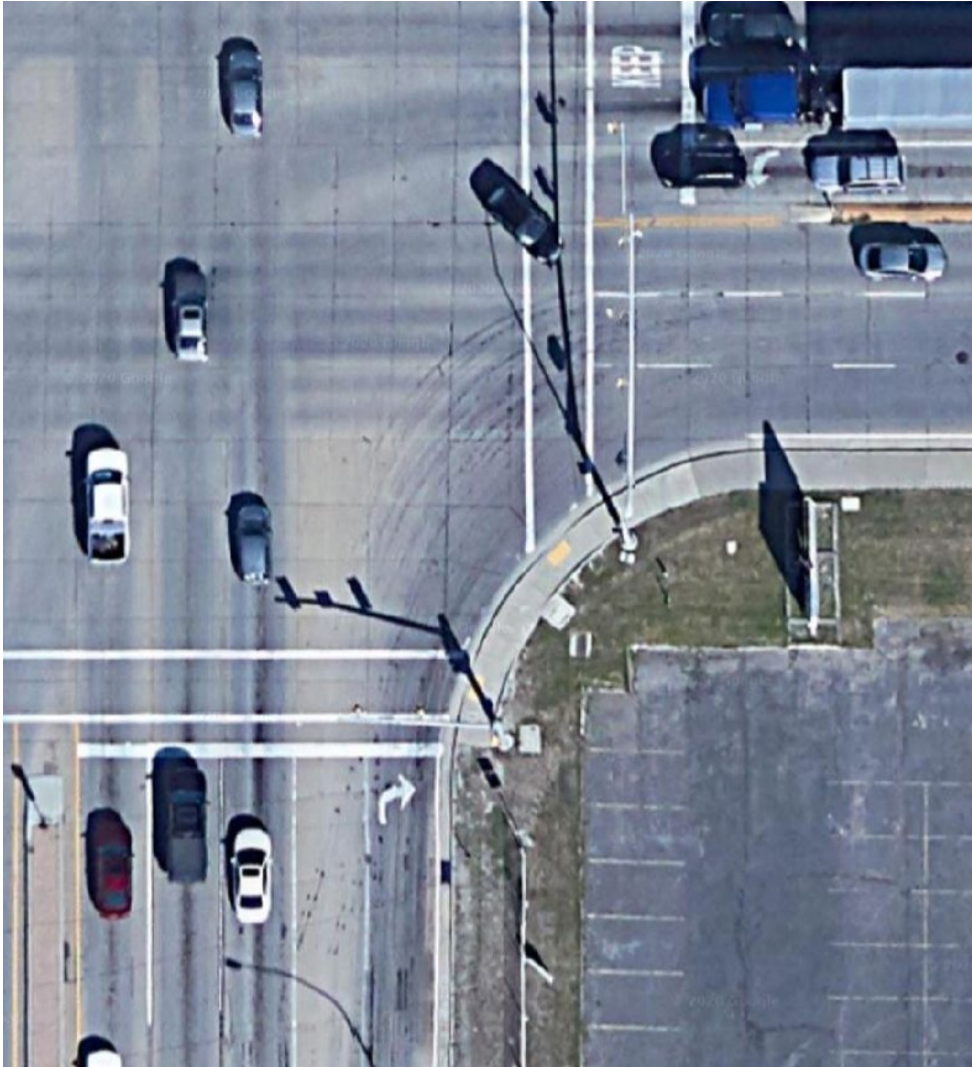

Large Intersections – Truck Aprons

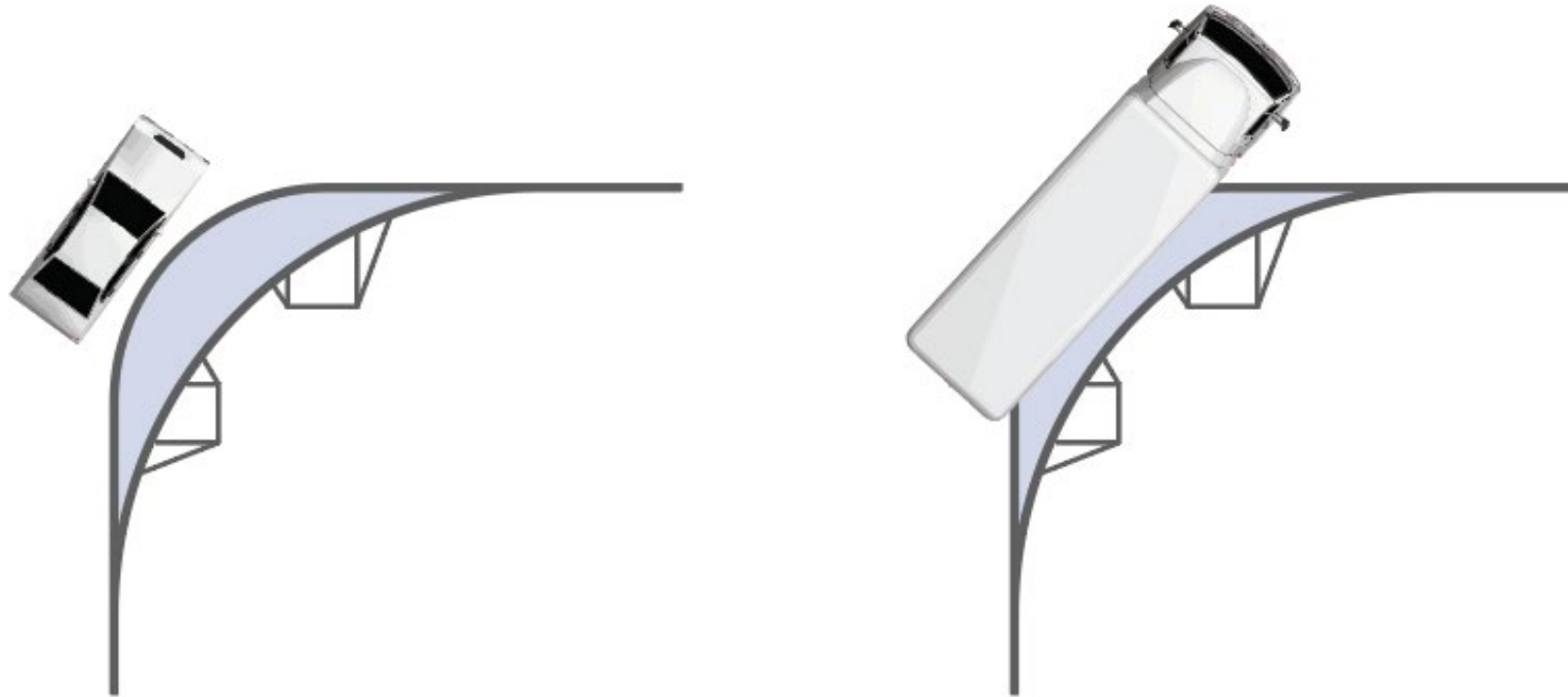

Large Intersections – Truck Aprons



Large Intersections Redesign



Large Intersections Redesign as Quick Build

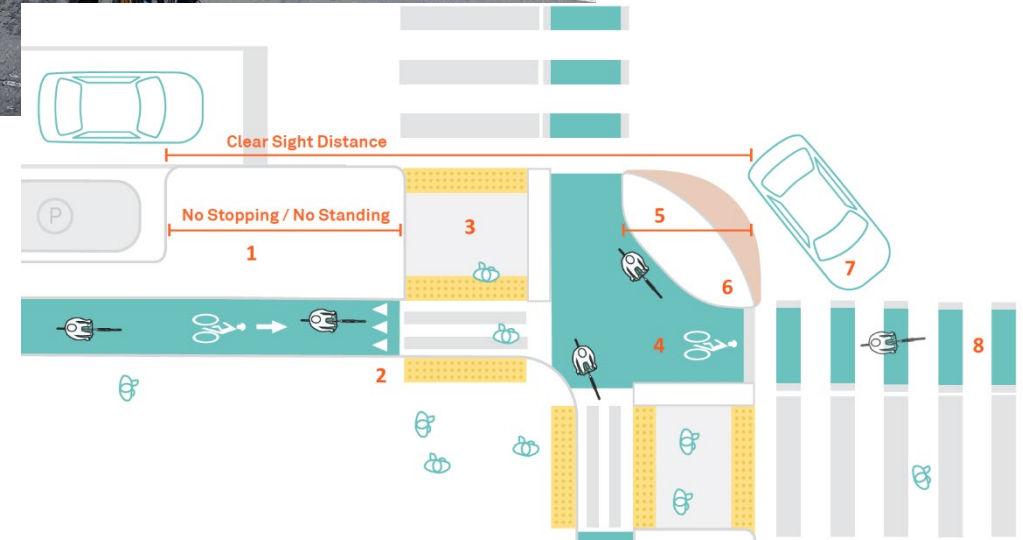
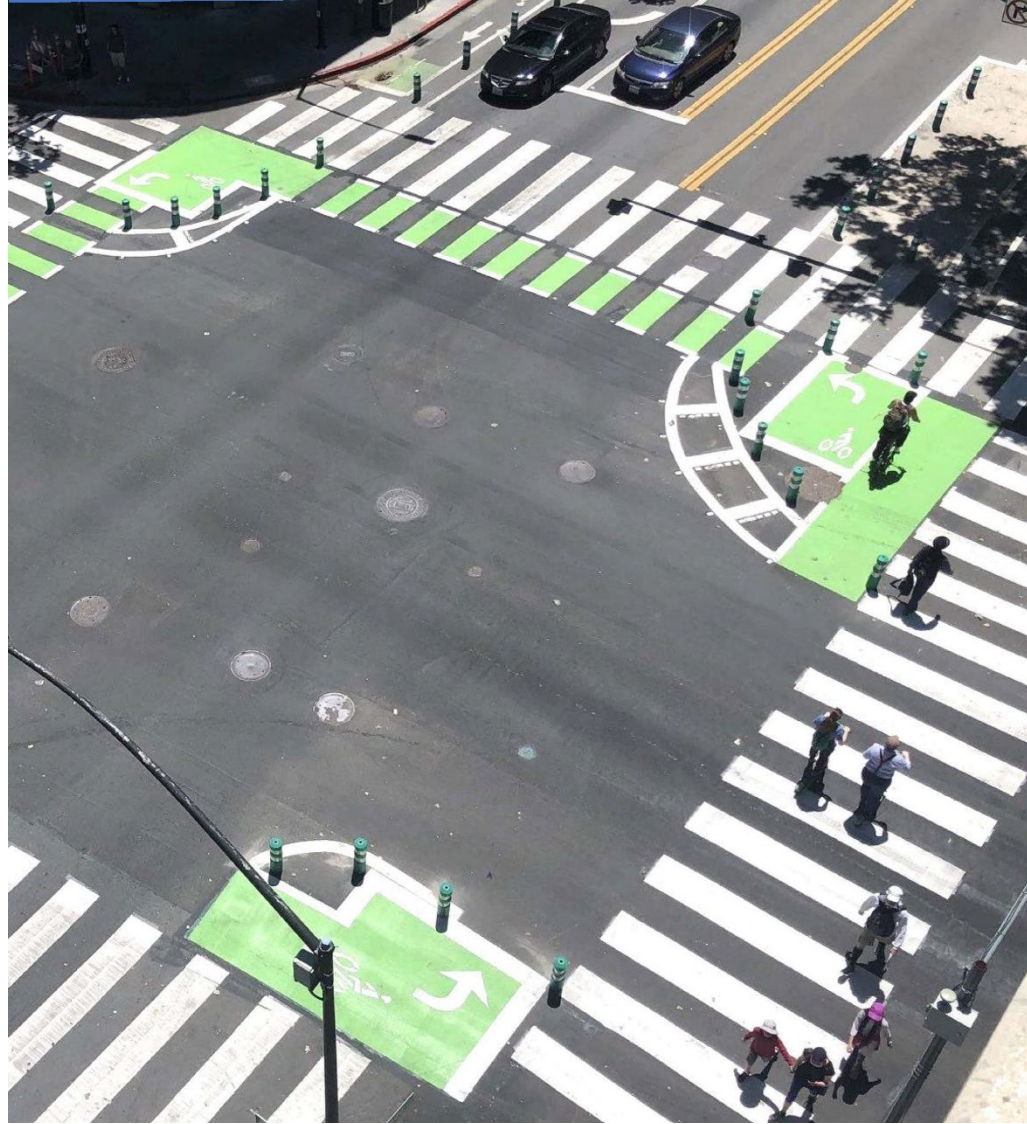

Large Intersections



Lower Cost Quick Build Projects



ALTERNATIVE CORRIDORS



Leverage good assets

Local Roadways

Advantages:

- Typically more than 60% of most cities!
- Already have more compatible conditions for walking/biking

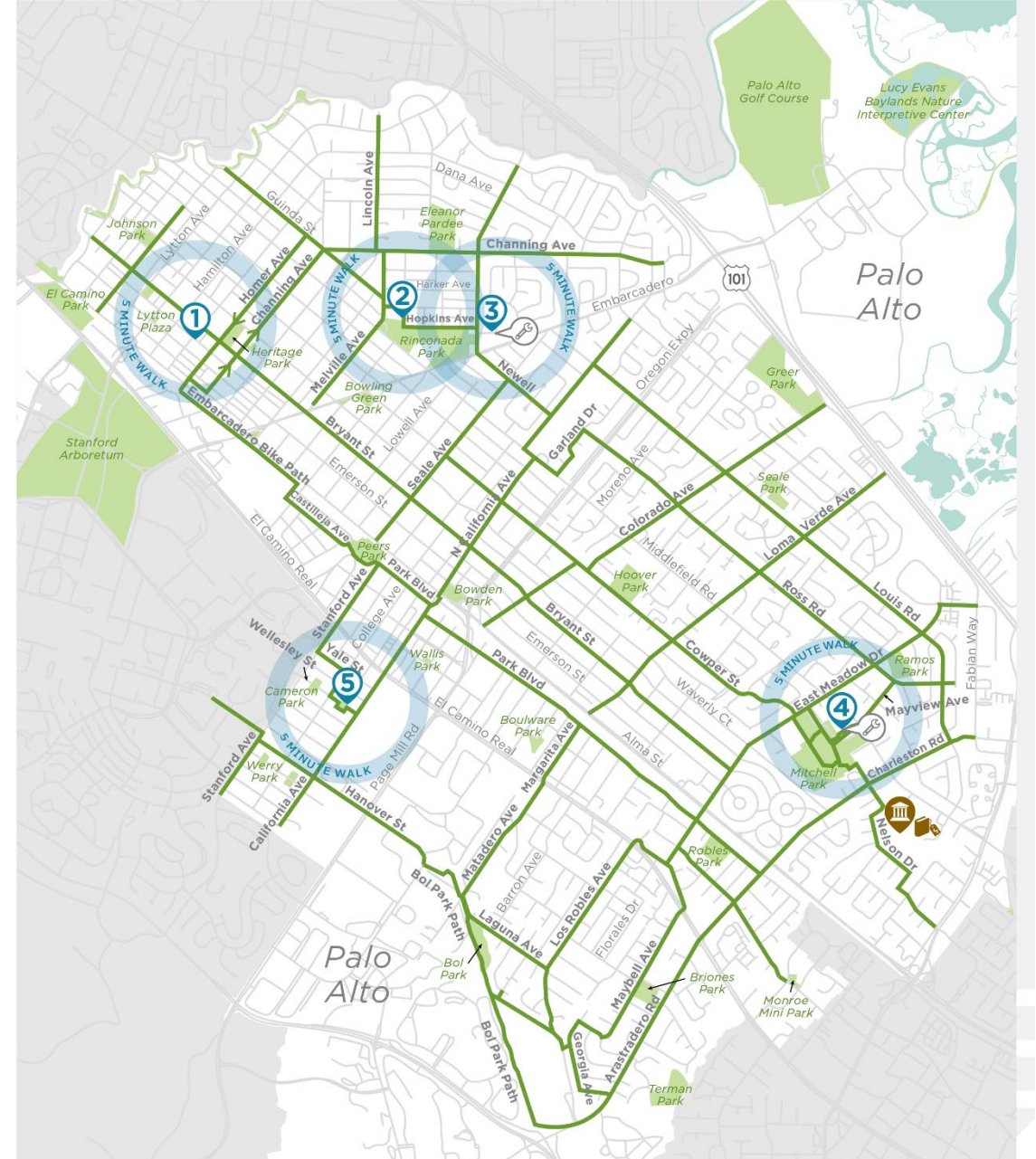

Toolkit: Traffic Calming

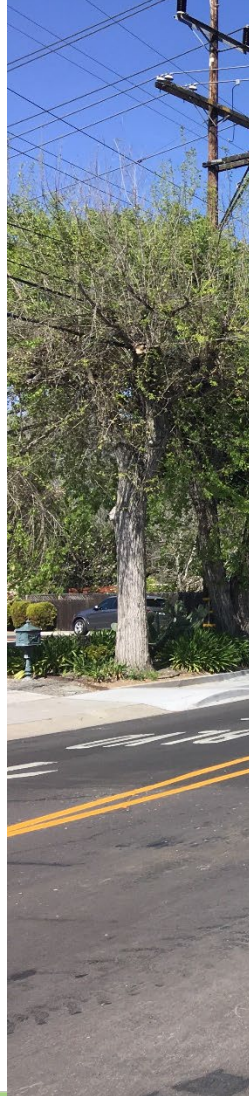

Toolkit: Major Street Crossings



Toolkit: Branding/Wayfinding

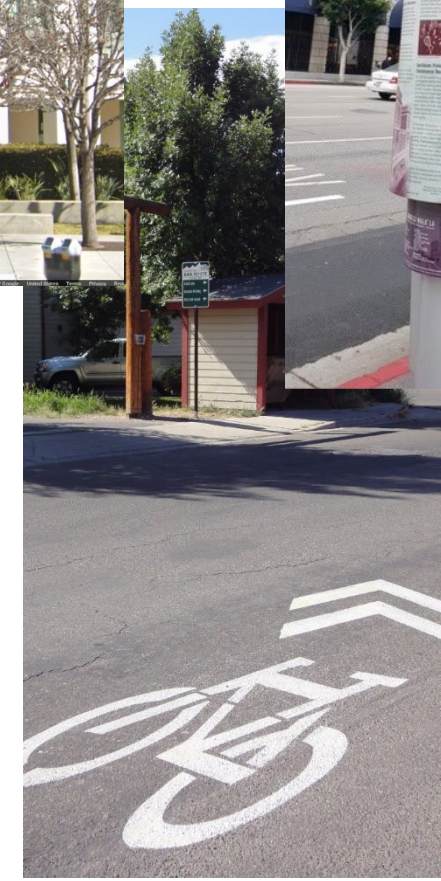
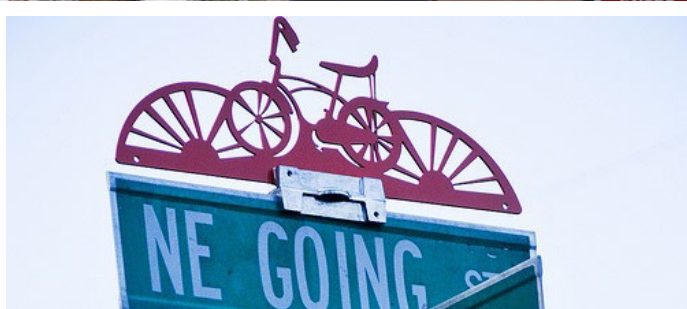



When Are Upcoming Funding Opportunities?

Patrick Gilster

SMCTA Manager of Programming & Monitoring

Utilize Funding

- Federal
 - RAISE
 - INFRA
- State
 - Active Transportation Program
 - Highway Safety Improvement Program
 - Local Partnership Program
- Regional/Countywide
 - Measure A (SMCTA)
 - Measure W (SMCTA)
 - Measure M (C/CAG)
 - One Bay Area (MTC)

C/CAG Comprehensive Bicycle & Pedestrian Plan (2021) includes a complete list of state and local funding sources:

Funding Source	Administering Agency	Weblink
State Funding Sources		
California Active Transportation Program	California Transportation Commission	www.dot.ca.gov/hq/LocalPrograms/atp
California Office of Traffic Safety Grants	California Office of Traffic Safety	www.ots.ca.gov/Grants/default.asp
Highway Safety Improvement Program	Caltrans	www.dot.ca.gov/hq/LocalPrograms/hsip.html
Affordable Housing and Sustainable Communities Program	California Strategic Growth Council	www.sgc.ca.gov/Grant-Programs/AHSCProgram.html
Sustainable Transportation Planning Grants	Caltrans	https://dot.ca.gov/programs/transportation-planning/regional-planning/sustainable-transportation-planning-grants
Recreational Trails Program	California Department of	http://ohv.parks.ca.gov/?page_id=24881

<https://ccag.ca.gov/wp-content/uploads/2021/06/San-Mateo-County-Comprehensive-Bicycle-and-Pedestrian-Plan-Update-Final-Plan.pdf>



How will the TA incorporate Complete Streets?

- **Highway Program:**

- Measure W allows pedestrian and bicycle projects along/across the highway system to be funded
- Projects of Countywide Significant are being re-evaluated to include multimodal elements

- **Bicycle & Pedestrian Program:**

- Quick build projects may be prioritized for the small capital projects category
- Class III Bike Routes will no longer be funded, only Neighborhood Routes with sufficient traffic calming
- Jurisdictions will need to show bike projects improve comfort levels
- Extra “readiness” points will be given for jurisdiction staff who attend SMCTA technical trainings



2022 Calls for Projects Opportunities

Alternative Congestion Relief (ACR) & Transportation Demand Management (TDM) Program

- CFP will be released in **April**
- Example projects include:
 - TDM Plans
 - Mobility Hub Planning/Design
 - Transit Pass or E-bike Subsidies
 - Bike Parking & Lockers
 - Transit access improvements and bike/ped spot treatments

Sub-Categories	Competitive Funds
ITS Planning & Design	\$885,600.00
TDM Competitive Funds	\$3,075,000.00
<i>Small/Coastal (30%)</i>	\$922,500.00
<i>Mid/Large (70%)</i>	\$2,152,500.00
ACR/TDM Planning Funds	\$775,800.00
Total	\$4,736,400.00

For more information on this category, see the recently adopted SMCTA ACR/TDM Plan:

https://www.smcta.com/Projects___Programs/TDM.html



2022 Calls for Projects Opportunities

Bicycle & Pedestrian Program

- CFP will be released in **August**
- Example plans:
 - Bike & Pedestrian Plans
 - Implementation/Feasibility Studies for Priority Corridors
 - Vision Zero/High Injury Networks
- Example capital projects
 - Separated Class IV Bikeways
 - Quick Build Bicycle & Pedestrian Projects
 - Pedestrian crossing treatments

Sub-Categories	Competitive Funds
Capital	\$16,713,350
<i>Capital - Large</i>	\$11,197,945
<i>Capital - Small</i>	\$5,545,676
Planning/Promotion	\$592,325
Safe Routes to School	\$439,825
Total	\$17,775,771

For more information on this category and see past successful projects visit:

https://www.smcta.com/Projects___Programs/Pedestrian_and_Bicycles.html



Berkeley SafeTREC Free Programs

Complete Streets Safety Assessments

- Applications due February 15th
- Great opportunity for either:
 1. Communities with recent Ped/Bike Plans to identify potential improvements for priority corridors
 2. Communities without Ped/Bike Plans to identify projects

For More Information visit:

<https://safetrec.berkeley.edu/programs/complete-streets-safety-assessments-cssa>

Community Pedestrian & Bicycle Safety Trainings

- Rolling Applications
- Great opportunity for either:
 1. Communities/neighborhoods where engagement with residents is needed to identify projects
 2. Small-scale safety or future corridor projects

For More Information visit:

<https://safetrec.berkeley.edu/programs/cpbst>





Thank you!

If you have any questions please contact:

Patrick Gilster at gilsterp@samtrans.com

Heba El-Guindy at el-guindyh@samtrans.com